

AMERICA'S FOOT SWITCH LEADER

Full Line Catalog



TABLE OF CONTENTS

Corporate Capabilities	4
Industrial Applications & Products	6
Medical Applications & Products	8
Customization	10
Design & Production	14
Quality	15
Wireless Technology	16
Corporate History	17
Special Variations (OEM)	18
Application Cross Reference	19

Linemaster Switches

Hercules Anti-Trip	21-25
Hercules	26-29
Atlas	30-33
Explosion Proof	34-37
Industrial	34, 35
Medical	36, 37
Classic IV Linear	38
Classic IV	39, 40
Classic II	41
Classic	42
Classic - Reed	43
Nautilus	44
Clipper	45, 46
Clipper II	47
Junior	48
Deluxe	49
Deluxe II	50
Aquiline	51-53
Compact	54
Compact II	55
Hi-Treadlite	56
Treadlite II	57-58
Treadlite F	59
Dolphin	60
Premier	61

Symbols Used In This Catalog

 LD LIGHT DUTY	 MD MEDIUM DUTY	 HD HEAVY DUTY	 HEEL TOE ROCKER Rocker Switch Heel / Toe
 FCC Licensed	 FDA 510(k) Clearance	 RoHS Compliant	 ROCKER Rocker Switch Left / Right

Gem-V & VK	62
Executive	63
Lektro-Lok	64
Duplex	65
Pneumatic AirVals	66-71
Premier	66
Hercules	67
Clipper	68, 69
Compact	70
Classic	71
Air Switches	72-74
Air-Seal	72
Vanguard	73
Omega	74
Electronic AC Speed Control	75
Variable	76-80
Hercules Potentiometer	76-79
Varior Potentiometer	80
Throttle Control	81
Enclosures	81
Assemblies	81
Slim-Line	82
Wireless Switches	83-92
RF Wireless - Hercules	83
RF Wireless - Digital	84-86
IR Wireless - Digital	87-89
IR Wireless - Linear	90-92
Accessories	93-95
Shields	93
Awareness Cover	93
Guards	94, 95
Vinyl Boot	95
Cordset & Molded Plug Information	96
Cord Information	97
IP Ratings Explained	98, 99
Agency Markings & Approvals	100
Glossary of Terms	101
Commitment To Quality	102
! WARNING !	103

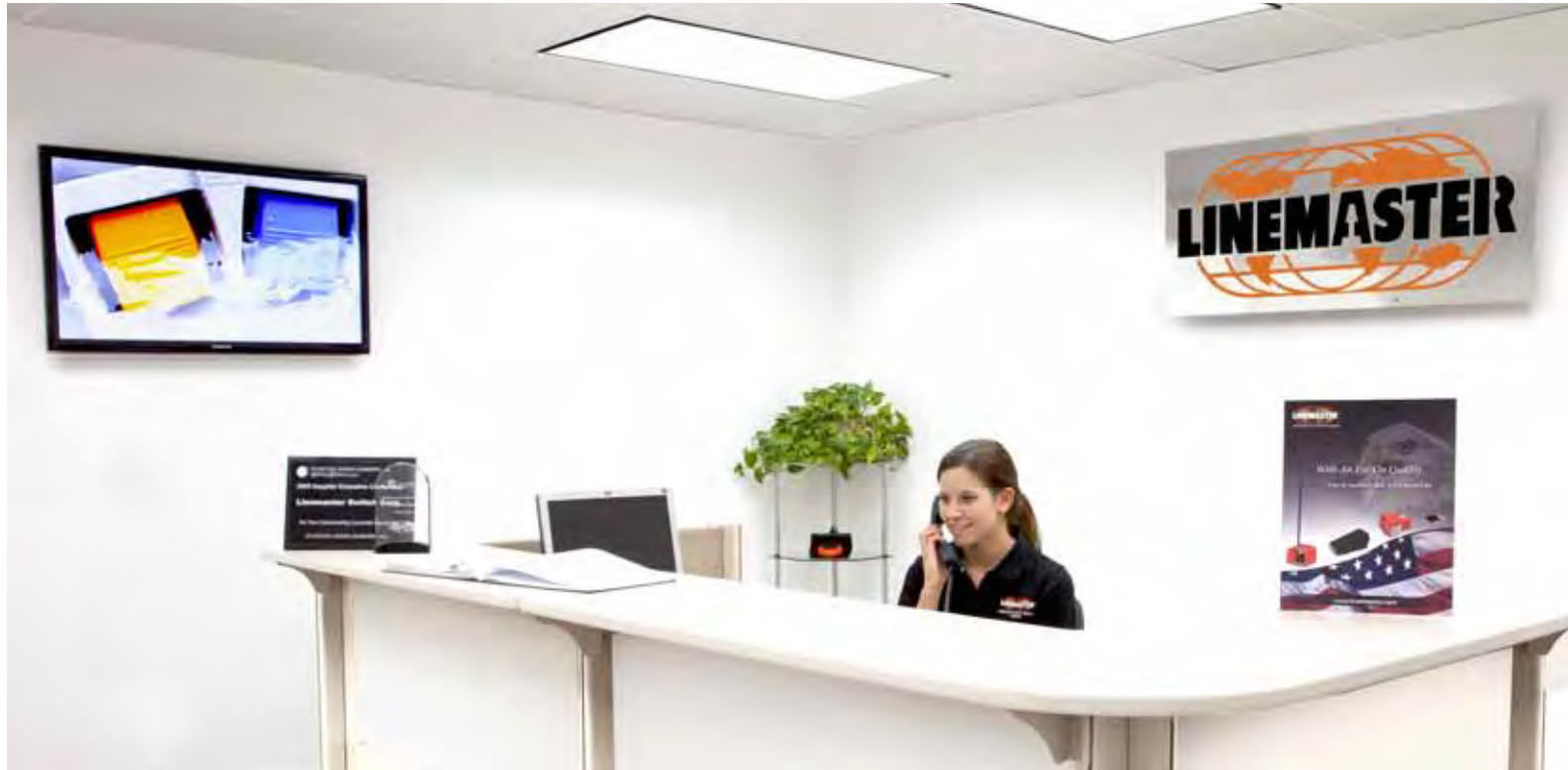

CORPORATE CAPABILITIES

Linemaster is the global leader in manufacturing foot switches for medical and industrial applications. The world's best and largest original equipment manufacturers turn to Linemaster for highly-engineered, custom, foot control products. Whether you need traditional, standard, custom, wireless, durable industrial, or medical-grade foot controls, Linemaster's experience and extensive capabilities gives you a competitive edge.

Highly engineered foot control products, FDA-cleared capabilities, innovative and flexible design: no wonder Linemaster is the leading foot switch manufacturer in the world and a giant in the US market, where we are 25 times bigger than the next biggest competitor. We reached this status by focusing solely on what we do best: foot controls.

Linemaster's mission is to provide a superior foot switch at an affordable price without compromise. This mission is met every single day.



29 Plaine Hill Road
POB 238
Woodstock, CT 06281-0238 USA

Call: (860) 974-1000
Fax: (860) 974-0691
Fax Toll Free (US Only): (800) 974-3668

www.linemaster.com



LINEMASTER INDUSTRIAL APPLICATIONS AND PRODUCTS

Linemaster delivers unmatched capabilities to design and manufacture foot controls with limitless applications. From heavy duty to light duty, traditional to wireless, Linemaster foot controls and accessories are widely recognized as the best in the world.

Since its founding in 1952, Linemaster has come to be the standard by which all other foot switches are judged. Linemaster was the first to market with an IR wireless foot switch that met the exacting demands of our customers.

- Electromechanical
- Pneumatic
- Linear Hall Effect
- Digital and Linear Switches
- Wireless IR and RF

In addition to its full-service custom foot switch operations, Linemaster offers more than 550 standard catalog models, more than any other manufacturer in the global marketplace. We aggressively develop and produce cutting-edge technologies that meet and anticipate our customers' needs. With a complete range of electric, air-powered, variable speed, and wireless foot switches, we have made turnkey and custom variations a specialty.

LINEMASTER FOOT CONTROLS AT WORK IN THE INDUSTRIAL WORLD

- Adhesive Dispensers
- Abrasive Blasters
- Packaging Equipment
- Conveyers
- Material Handling Equipment
- Man Lifts
- Communications Equipment
- Lighting
- Engine Brake
- Alarms / Security
- Emergency Vehicles - Siren / Horn
- Terminal Applicators
- Degreasers
- Metal Working Machines
- Electric Vehicles
- Farm Equipment
- Engravers Machinery
- Scissor Lifts
- Riveting Machinery
- Soldering / Desoldering / UV Curing / Welding Equipment





Linemaster foot controls are in use in hundreds of Industrial applications.

LINEMASTER MEDICAL APPLICATIONS AND PRODUCTS

With Linemaster, you get more than a manufacturer of high-quality medical grade foot switches, you have a partner that will lead you through the sometimes difficult regulatory and compliance processes associated with the medical industry. Our regulatory know-how, FDA clearances, and respected universal quality management systems will ensure that your product meets the high requirements for safety, reliability, function, and ergonomics.

Linemaster's track record speaks for itself: we have proven success working with the most rigorous medical specifications in the world. The most renowned medical device companies have turned to Linemaster again and again for the best medical foot controls available worldwide.

Linemaster processes and quality systems are proven to result in the best and most reliable medical grade foot switches available.

Linemaster's quality management systems include:

- **FDA 510(k):** Linemaster is the only foot control company in the world to obtain FDA 510(k) Clearance on an IR Wireless Foot Switch.
- **ISO 13485:2003:** This internationally recognized Quality Management Systems Standard was established for the design and manufacture of medical devices. Linemaster has demonstrated the ability to successfully implement a comprehensive management system for the design and manufacture of medical devices that meet the ISO Standard, FDA QSR, and regulatory requirements. The addition of the ISO 13485:2003 Certification to the existing ISO 9001:2008 registration and FDA 510(k) clearance reflects Linemaster's commitment to continuous improvement with the Quality process.
- **Linemaster Quality Policy:** We are committed to provide the highest standard quality products and services that will meet or exceed our Customers' requirements, comply with regulatory requirements, and to maintain and improve the effectiveness of the quality management system.

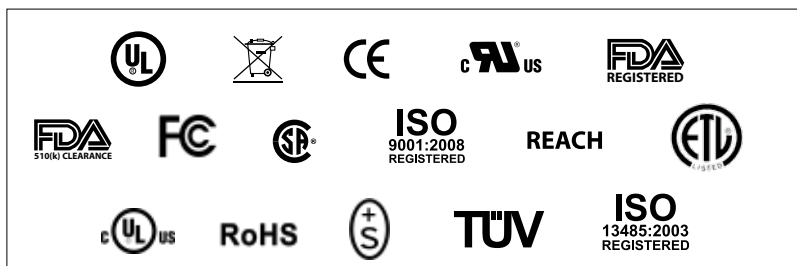

We are proud that we have the longest list of satisfied customers in high profile, start-up, and mid-level businesses worldwide. Our diverse background means that we have catered to a multitude of diverse medical grade foot switch applications. If you can think of an application, Linemaster has probably already designed a foot switch solution for it.

LINEMASTER FOOT CONTROLS AT WORK IN THE MEDICAL WORLD

Linemaster holds approximately 90 percent of the medical OEM foot control business in the US market. You will find Linemaster Foot Controls being used in conjunction with the following medical equipment:

- Electrosurgical Generators
- Biopsy Systems
- Bone Saws
- CT Scanners
- Dental Chairs
- Medical Lasers
- Endoscopy
- Fluoroscopes
- Liposuction
- Laparoscopic Surgery
- Medical Cameras
- Medical Tables
- MRI Systems
- Surgical Navigation Systems
- Ophthalmic Surgery
- Surgical Shavers
- Lighting Controls
- Surgical Visualization & Image Management Systems
- Surgical Microscopes
- Ultrasonic Diagnostic Systems
- X-Ray Equipment (C-Arm)
- Mammography





Linemaster foot controls are in use in hundreds of medical applications.

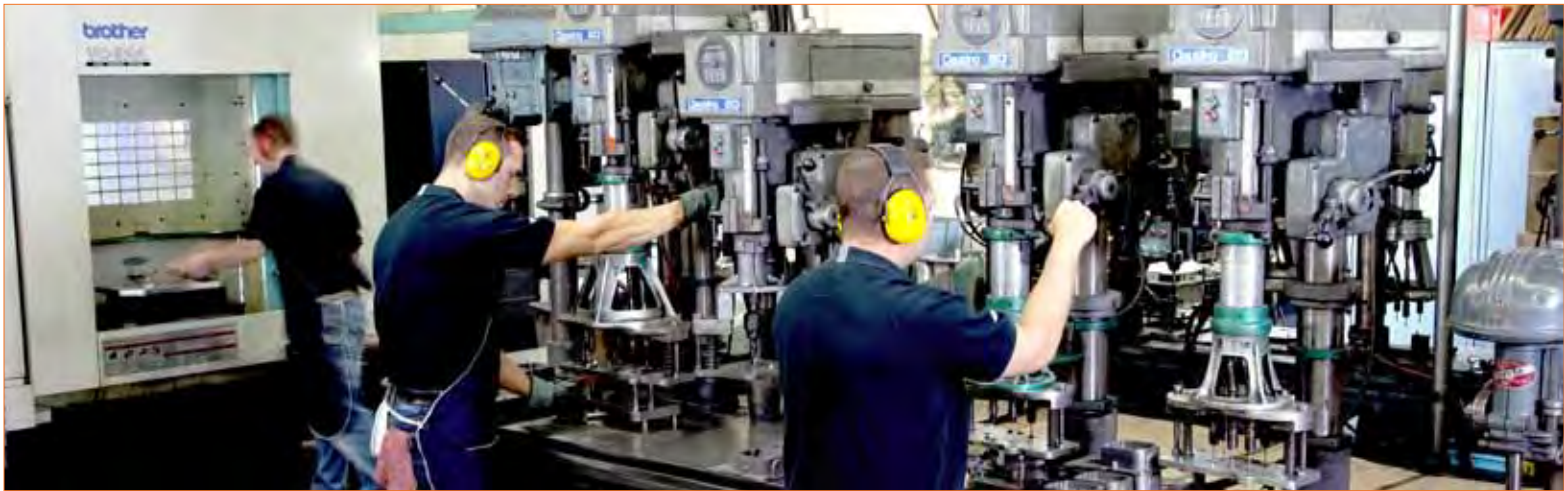

LINEMASTER CUSTOMIZATION

*manufactured to meet the specific needs of
Original Equipment Manufacturers (O.E.M.)*

Linemaster is the primary partner in all O.E.M. needs. From original engineering and design to special paint finishes, nameplates, mounting provisions, and packaging, Linemaster makes your specific product possible – and profitable. Linemaster can bring to bear its extensive experience to design a foot control that meets your specific needs, saving you time to market and avoiding costly design pitfalls.

O.E.M options include:

- Private Label
- Custom Nameplate Service
- Gold Alloy Contacts
- Multipedal Controls
- Custom Cordset Service
- Multiple Listing
- CE Marking
- FDA Approval
- UL Standards
- Restriction of Hazardous Substances
- Waste Electrical and Electronic Equipment
- Material Safety Data Sheets
- Environmental Performance
- Handle Options
- Toe Loops
- Wired or Wireless
- Strain Relief Considerations
- Custom Color Matching
- Silk Screen And Pad Printing
- Anti Skid Foot Pads and Base Pads





29 Plaine Hill Road
POB 238
Woodstock, CT 06281-0238 USA

Call: (860) 974-1000
Fax: (860) 974-0691
Fax Toll Free (US Only): (800) 974-3668

www.linemaster.com





Every medical-grade foot control we manufacture is built in our Medical White Room, which features ESD Safe Construction for handling electronics, such as anti-static pads, grounded chairs, and grounding bracelets for technicians.

More than **90%** of the world's largest original equipment manufacturers turn to Linemaster for their medical grade foot controls.

At Linemaster, we know how to navigate and meet industry standards and regulations, from the FDA to Underwriters Laboratories, the U.S Department of Commerce, and international regulators, we have established working relationships and industry knowledge that can be leveraged for your product. All Linemaster foot switches are UL Listed, CSA Certified or UL Recognized Components. Under UL and CSA Multiple Listing Programs, it is possible to include the UL or CSA insignias on nameplates. In addition to the familiar NEMA, UL and CSA enclosure types, LINEMASTER® offers a variety of standard foot switches that meet IEC 529, Type IP68 and/or IEC 60601-2-2, Section 44, Subparagraph aa requirements for protection against access to and the entrance of foreign objects and water to the electrical switching elements and connections. This is accomplished by either sealing the enclosure or the switching element itself. Virtually all of our foot switch families can be constructed to accommodate these requirements as a special variation for the O.E.M.

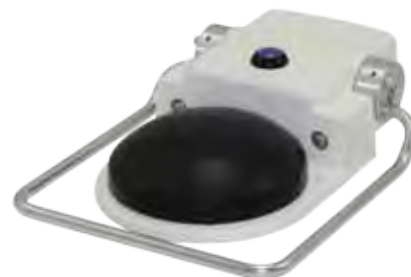
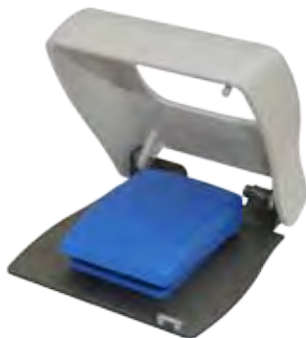



29 Plaine Hill Road
POB 238
Woodstock, CT 06281-0238 USA

Call: (860) 974-1000
Fax: (860) 974-0691
Fax Toll Free (US Only): (800) 974-3668

www.linemaster.com



LINEMASTER DESIGN AND PRODUCTION

Linemaster's Creative Design Team keeps your bottom line top of mind. Our team ensures that there is minimal, if any, non-recurring engineering expenses. Tooling is provided at cost. In-house artwork capabilities and an on-site printed circuit board lab means that outstanding flexibility and ingenuity are within budget. New technologies are at our fingertips, such as Infrared Wireless, Radio Frequency, Hall Effect Linear Devices, Magnetically Immune Circuitry for MRI Suite applications, Pneumatic, Pneumatic Linear Actuators, USB, RS232, RS485, and tapered linear feedback foot controls. Custom cable, sizes, weight, functionality, handles, toe loops, paint, silk screen, base pads, dividers, electronics, LED's, and guards- the possible features of a new custom design are nearly limitless.

Once your custom design is complete, our production process begins, and you're in good hands, literally. Linemaster's trained and certified technicians are carefully selected to assemble and test our sophisticated medical-grade foot controls with state-of-the-art equipment. We have a LEAN Manufacturing professional on site, and our well-organized facility enables optimum workflow. Linemaster offers Vertically Integrated Human Resources, with hundreds of years of degreed and real-world engineering that is working for you.





LINEMASTER QUALITY AND TESTING

Linemaster's rapid prototyping capabilities mean that your custom foot control is in pilot stage quickly and efficiently. Design validation prototypes and production runs lead our extensive testing protocols. Linemaster utilizes Automated Testing Equipment, a water-testing room to test IP68 foot controls, Hypot Test Equipment for first piece inspection, Drop Tests, Pull Tests for testing cable and strain reliefs, Flex Testing of cables, as well as Continuity, Shipping, Environmental, mean time between failure (or Life), and Impact tests.

Through it all, Linemaster's team is managing proper documentation. Project files containing emails, customer drawings, Linemaster preliminary drawings, and any other correspondence are kept to track the entire life of the project. Every step is traceable through barcode labeling, serial numbering, intelligent part numbers, and date coding – everything you need for any and all global market regulatory agencies.

Linemaster's trained and certified technicians are carefully selected to assemble and test our foot controls with state-of-the-art equipment. From custom design to finished product, Linemaster's promise of timely delivery of the highest possible quality product is met every day.





UNPARALLELED WIRELESS CAPABILITIES

Get wireless technology and limitless capability from the company that was first to market with a wireless footswitch that met the high demands of our customers. Linemaster is also the only foot control company in the world to obtain FDA 510(k) Clearance on an IR Wireless Foot Switch.

Linemaster's IR and RF wireless foot controls provide the ease of use, mobility, and hygiene while meeting the stringent safety and reliability requirements – whether your needs are medical or industrial.

The IR Wireless foot control offers reliable reception by saturating a room with 360 degrees of high power, invisible, Infrared light waves. Encrypted coding allows for multiple systems to be used in the same vicinity at the same time with no interruption or cross talk while utilizing a 50-foot transmission range. Linemaster IR Wireless foot switches are available in single, twin and triple variations offering up to (5) switch functions.

Linemaster's standard RF Wireless foot controls are offered with up to (5) digital and (3) analog switch functions with additional switch

functions available upon request. Linemaster's RF Technology utilizes the well-established IEEE 802.15.4 Standard and operates in the worldwide ISM 2.4 GHz frequency band. Our unique and robust proprietary communication scheme does not require the use of bi-directional link or acknowledgement, which greatly reduces the amount of air traffic and potential interference. This proprietary design also offers a battery life that is second to none.

All of Linemaster's Wireless foot controls offer a unique "plug and go" system perfect for new applications or as a replacement for existing wired solutions. Both types of Wireless technology are battery-powered and provide 700 hours at 50 percent duty cycle, which could translate to years of operating life depending on the application.

Whether you are seeking industrial or medical grade wireless foot controls, Linemaster provides the technological know-how you need.

No one offers more possibilities for wireless foot controls than Linemaster. Our single, twin, triple, and multi-function variations can be custom designed and manufactured to your exacting specifications.



Corporate Headquarters 29 Plaine Hill Road, POB 238 Woodstock, CT 06281-0238 USA

THE BEST AND THE FIRST IN FOOT CONTROLS

For six decades the name Linemaster has been synonymous with the highest standards of performance in providing Foot Control solutions for manufacturers worldwide. Our international reputation for excellence has evolved through ongoing research and development, innovative design, customer service, and a commitment to style and quality that is unparalleled in the industry.

Linemaster's history is rooted from innovation and today is no exception. From the introduction of the world's first footswitch mid 1930's to the custom built series of wireless foot controls of today, Linemaster continues to exceed customer expectations over and over again in every aspect of reliability, functionality, and design.

Linemaster's first foot control was created in 1937, by Albert Simonds, who needed to operate his lens grinding machinery while keeping his hands free at all times. Consequently, he perfected the foot

switch and thus the Linemaster story begins. Demand for his unique product grew and, by 1952, Linemaster was officially established as a privately owned and operated manufacturing facility in the state of Connecticut. Today, Linemaster's 45,000 square-foot facility in Woodstock, Connecticut, which houses a state-of-the-art Electronic White Room specifically designed for the assembly of medical-grade controls, produces more than a million foot switches each year.

In 2009, Linemaster's opened the doors to its second facility, in nearby Plainfield, Connecticut, which contains a warehouse, cable technician department, and other various business functions. Linemaster's second facility occupies 15,000 square feet and much needed space for a fast growing company.

Linemaster: setting the standards for foot controls since 1937.

SPECIAL VARIATIONS - ORIGINAL EQUIPMENT MANUFACTURERS

Special Variations Availability

Special Variations are only available to the Original Equipment Manufacturer (O.E.M.) in production quantities. Specials are made to the O.E.M.'s specifications, and orders for specials are accepted on a direct basis only. Any modification to a standard catalog item, however slight, i.e. minus the nameplate, would be considered a special.

Multiple Listing-O.E.M.

All LINEMASTER® foot switches are UL Listed, CSA Certified or UL Recognized Components. Under UL and CSA Multiple Listing Programs, it is possible for the O.E.M. to include the UL or CSA insignias on their own nameplate. Please contact the factory for details.

CE Marking

Many of our foot switches are or, with modifications, can be CE Marked to meet the EC Low Voltage Directive. We are working with Underwriters Laboratories, TUV Product Service and TUV ESSEN to meet the needs of our customers requiring CE Marking to specific EN standards. Our foot switches are considered general use devices and see a wide variety of end uses. To this end we have an on-going long term project with UL to investigate our entire product line to various EN Standards.

It should be noted; a foot switch that is to be attached to a finished product by the Original Equipment Manufacturer need not be CE Marked. According to the U.S. Department of Commerce, we can ship our foot switches to the European Community provided the following declaration is made on the shipping documents: "These components are intended exclusively for an industrial assembly operation for incorporation in apparatus."

FDA

Many of our foot switches are used on a wide variety of medical device products. The FDA considers the foot switch to be a component and not an accessory when used with the manufacturer's finished medical device.

UL

Underwriters Laboratories
UL (Underwriters Laboratories, Inc.): Standards agency and testing laboratory for the United States. UL also has some limited involvement in international certifications.

RoHS

RoHS - Restriction of Hazardous Substances

WEEE

WEEE - Waste Electrical and Electronic Equipment

Private Labeling

With this option, the O.E.M. can order foot switches with a nameplate which is identical to our standard nameplate except the customer name and address would replace the LINEMASTER® name and address. All other information would remain the same.

We offer custom cordset services, so that we can provide a complete foot control assembly to the O.E.M.'s specifications. Special paint finishes, nameplates, mounting provisions and packaging are some of the options available to the O.E.M.

If a O.E.M. REPLACEMENT FOOT CONTROL assembly is required for a particular piece of equipment, we would suggest that direct contact be made with the O.E.M. for replacements, as all specials are made on a proprietary basis.

Custom Nameplate Service-O.E.M.

Special nameplates and custom WARNING labels are available to the O.E.M. as part of a special foot switch assembly or as separate items.

Gold Alloy Contacts-O.E.M.

In most applications that required a foot operated switch, our customers have found that one of our standard basic models have met their needs. In those special design applications that require a special foot control with gold alloy contacts, we can offer the O.E.M. a basic snap switch with SPDT gold alloy contacts rated 1 Amp 125 VAC in most of our foot switch housings. The use of this basic gold alloy snap switch, would delete all agency approvals where noted. Before a decision is made to specify gold alloy contacts, we would suggest that a standard foot switch model be evaluated in the particular application.

Multi Pedal Controls-O.E.M.

Many of our basic foot switch models can be mounted in combinations to provide multi function foot controls. Several of the more commonly required dual models are offered as standard twin units and are shown in the catalog and listed in the price sheet. Other multi pedal combinations are available to the O.E.M. on special order, in production quantities. Please refer to the back cover of the catalog for some representative examples. Up to eight DPDT functions can be incorporated in a single assembly.

Custom Cordset Service-O.E.M.

Custom cordsets are available to the O.E.M. as part of a complete foot switch assembly or as separate items. LINEMASTER® is a UL Recognized and CSA Certified source for Wiring Harnesses and Processed Wire.

Material Safety Data Sheets-Msds

LINEMASTER® products do not require Material Safety Data Sheets.

Environmental Performance

In addition to the familiar NEMA, UL and CSA enclosure types, LINEMASTER® offers a variety of standard foot switches that meet IEC 529, Type IP68 and/or IEC 60601-2-2, Section 44, Subparagraph aa requirements for protection against access to and the entrance of foreign objects and water to the electrical switching elements and connections. This is accomplished by either sealing the enclosure or the switching element itself.

Virtually all of our foot switch families can be constructed to accommodate these requirements as a special variation for the O.E.M.



***FOOT CONTROLS
AND
ACCESSORIES***



AMERICA'S FOOT SWITCH LEADER

ORDER ONLINE TODAY
Visit www.linemaster.com

NEMA Type 2, 4 & 13
UL ENCLOSURE 2, 4 & 13
CSA ENCLOSURE 2, 4 & 13
EN 60529 Degree of Protection IP56

Drip tight • Dust tight • Watertight • Oil tight
ADVANCED DESIGN HELPS PREVENT ACCIDENTAL ACTUATION



Materials of Construction:

- Treadle and housing constructed from cast iron for strength and durability
- Protected by a strong cast aluminum shield
- Special AirVal models available to the O.E.M. on special order
- Painted Alert Orange
- Single 3/4"-14 N.P.T. threaded conduit entry is standard

Features & Benefits:

- Heavy duty foot switch features an anti-trip treadle mechanism that helps prevent accidental actuation through unintentional stepping on foot treadle
- Switch operation requires that the latch trip lever be released prior to depressing the foot treadle as in-line foot pressure is applied to the latch trip lever located at the rear of the foot treadle
- Smooth trip lever release and treadle depression motion results in good rate of operation
- Dual treadle return springs and latching mechanism
- Anti-skid rubber feet and 3 holes for rigid mounting to floor or equipment
- All Models have a neoprene Cover Gasket plus O-Rings on the Actuating shaft and separate ground screw

Options:

- Oversize "O" and "OX" Shield models accept oversized safety shoes and metatarsal foot guards. The "OX" Shield has an additional 3/4" (19.1 mm) opening height as compared to the "O" shield
- Special Dual 1/2"-14 N.P.T. threaded conduit entry and metric sizes available to the O.E.M. on special order
- Special Twin & Triple models available to the O.E.M. on special order
- Gated Models available for additional protection (See "Hercules Anti-Trip - Gated..." on pages 24 & 25 for details)
- RF Wireless models are available (See "RF Wireless Hercules" on page 83 for details)

Size (HxWxD):	4.80 x 5.88 x 9.00 In.
Weight:	7.50 lbs.
<p><i>For Dimension Drawings visit www.linemaster.com and click on Line Drawings located under the Guides & Literature Tab</i></p>	

<p>⚠ WARNING SEE PRODUCT WARNING ON PAGE 103</p> <p>SPECIFICATIONS (Special variations are available to the O.E.M. on special order on the models listed below)</p>							
AGENCY APPROVALS	EN 60529 Degree of Protection	CATALOG NUMBER	DESCRIPTION	STAGE	CIRCUIT	FORM	ELECTRICAL RATINGS
	IP56	511-B	Momentary	Single	SPDT	C	20 A 125-250 VAC
	IP56	511-B2 ¹	Momentary	Single	DPDT	C	1 H.P. 125-250 VAC
	IP56	511-B2A	Momentary	Two	SPDT	C	Heavy Pilot Duty 250 VAC Max.
	IP56	511-B3	Momentary	Single	SPDT DB ²	Z	15 A 125-250 VAC
	IP56	511-B4 ¹	Momentary	Single	DPDT DB ²	Z	1/2 H.P. 125 VAC
	IP56	511-B4A	Momentary	Two	SPDT DB ²	Z	1 H.P. 250 VAC
							Heavy Pilot Duty 250 VAC Max.

¹One pole of these models has an adjustable actuating mechanism that enables you to make or break one pole before the other. EXAMPLE: You can break the N.O. Circuit long before you would remake a N.C. Circuit in a 511-B2.
²DB Double Break models must be wired to equal voltage sources and the same polarity. The loads should be on the same sides of the line.

Hercules Anti-Trip - O Shield



NEMA Type 2, 4 & 13
UL ENCLOSURE 2, 4 & 13
CSA ENCLOSURE 2, 4 & 13
EN 60529 Degree of Protection IP56

Drip tight • Dust tight • Watertight • Oil tight
ADVANCED DESIGN HELPS PREVENT ACCIDENTAL ACTUATION

Materials of Construction:

- Treadle and housing constructed from cast iron for strength and durability
- Protected by a strong cast aluminum Shield
- Special AirVal models available to the O.E.M. on special order
- Painted Alert Orange
- Single 3/4"-14 N.P.T. threaded conduit entry is standard

Features & Benefits:

- Heavy duty foot switch features an anti-trip treadle mechanism that helps prevent accidental actuation through unintentional stepping on foot treadle
- Switch operation requires that the latch trip lever be released prior to depressing the foot treadle as in-line foot pressure is applied to the latch trip lever located at the rear of the foot treadle
- Smooth trip lever release and treadle depression motion results in good rate of operation
- Dual treadle return springs and latching mechanism
- Anti-skid rubber feet and 3 holes for rigid mounting to floor or equipment
- All Models have a neoprene Cover Gasket plus O-Rings on the Actuating shaft and separate ground screw

Options:

- Oversize "O" and "OX" Shield models accept oversized safety shoes and metatarsal foot guards. The "OX" Shield has an additional 3/4" (19.1 mm) opening height as compared to the "O" shield
- Special Dual 1/2"-14 N.P.T. threaded conduit entry and metric sizes available to the O.E.M. on special order
- Special Twin & Triple models available to the O.E.M. on special order
- Gated Models available for additional protection (See "Hercules Anti-Trip - Gated..." on pages 24 & 25 for details)
- RF Wireless models are available (See "RF Wireless Hercules" on page 83 for details)



SIZE (HxWxD):	5.31 x 5.88 x 9.13 In.
WEIGHT:	8.00 lbs.

For Dimension Drawings visit www.linemaster.com and click on Line Drawings located under the Guides & Literature Tab

⚠ WARNING SEE PRODUCT WARNING ON PAGE 103

SPECIFICATIONS (Special variations are available to the O.E.M. on special order on the models listed below)

AGENCY APPROVALS	EN 60529 Degree of Protection	CATALOG NUMBER	DESCRIPTION	STAGE	CIRCUIT	FORM	ELECTRICAL RATINGS
UL, UL, UL	IP56	511-BO	Momentary	Single	SPDT	C	20 A 125-250 VAC 1 H.P. 125-250 VAC Heavy Pilot Duty 250 VAC Max.
UL, UL, UL	IP56	511-B2O ¹	Momentary	Single	DPDT	C	
UL, UL, UL	IP56	511-B2OA	Momentary	Two	SPDT	C	
UL, UL, UL	IP56	511-B2OAC ^{2,3}	Momentary	Two	SPDT	C	
UL, UL	IP56	511-B3O	Momentary	Single	SPDT DB ²	Z	15 A 125-250 VAC 1/2 H.P. 125 VAC 1 H.P. 250 VAC Heavy Pilot Duty 250 VAC Max.
UL, UL	IP56	511-B4O ¹	Momentary	Single	DPDT DB ²	Z	
UL, UL	IP56	511-B4OA	Momentary	Two	SPDT DB ²	Z	

¹One pole of these models has an adjustable actuating mechanism that enables you to make or break one pole before the other. EXAMPLE: You can break the N.O. Circuit long before you would remake a N.C. Circuit in a 511-B2.

²DB Double Break models must be wired to equal voltage sources and the same polarity. The loads should be on the same sides of the line. ³"C2" designates dual 1/2" - 14 NPT conduit entry.

NEMA Type 2, 4 & 13
UL ENCLOSURE 2, 4 & 13
CSA ENCLOSURE 2, 4 & 13
EN 60529 Degree of Protection IP56

Drip tight • Dust tight • Watertight • Oil tight
ADVANCED DESIGN HELPS PREVENT ACCIDENTAL ACTUATION

Materials of Construction:

- Treadle and housing constructed from cast iron for strength and durability
- Protected by a strong cast aluminum Shield
- Special AirVal models available to the O.E.M. on special order
- Painted Alert Orange
- Single 3/4"-14 N.P.T. threaded conduit entry is standard

Features & Benefits:

- Heavy duty foot switch features an anti-trip treadle mechanism that helps prevent accidental actuation through unintentional stepping on foot treadle
- Switch operation requires that the latch trip lever be released prior to depressing the foot treadle as in-line foot pressure is applied to the latch trip lever located at the rear of the foot treadle
- Smooth trip lever release and treadle depression motion results in good rate of operation
- Dual treadle return springs and latching mechanism
- Anti-skid rubber feet and 3 holes for rigid mounting to floor or equipment
- All Models have a neoprene Cover Gasket plus O-Rings on the Actuating shaft and separate ground screw

Options:

- Oversize "O" and "OX" Shield models accept oversized safety shoes and metatarsal foot guards. The "OX" Shield has an additional 3/4" (19.1 mm) opening height as compared to the "O" shield
- Special Dual 1/2"-14 N.P.T. threaded conduit entry and metric sizes available to the O.E.M. on special order
- Special Twin & Triple models available to the O.E.M. on special order
- Gated Models available for additional protection (See "Hercules Anti-Trip - Gated..." on pages 24 & 25 for details)
- RF Wireless models are available (See "RF Wireless Hercules" on page 83 for details)



SIZE (HxWxD):	5.78 x 6.03 x 9.13 In.
WEIGHT:	8.25 lbs.

For Dimension Drawings visit www.linemaster.com and click on Line Drawings located under the Guides & Literature Tab

⚠ WARNING SEE PRODUCT WARNING ON PAGE 103

SPECIFICATIONS (Special variations are available to the O.E.M. on special order on the models listed below)

AGENCY APPROVALS	EN 60529 Degree of Protection	CATALOG NUMBER	DESCRIPTION	STAGE	CIRCUIT	FORM	ELECTRICAL RATINGS
UL, IEC	IP56	511-BOX	Momentary	Single	SPDT	C	20 A 125-250 VAC
UL, IEC	IP56	511-B2OX ¹	Momentary	Single	DPDT	C	1 H.P. 125-250 VAC
UL, IEC	IP56	511-B2OXA	Momentary	Two	SPDT	C	Heavy Pilot Duty 250 VAC Max.
UL, IEC	IP56	511-B3OX	Momentary	Single	SPDT DB ²	Z	15 A 125-250 VAC
UL, IEC	IP56	511-B4OX ¹	Momentary	Single	DPDT DB ²	Z	1/2 H.P. 125 VAC
UL, IEC	IP56	511-B4OXA	Momentary	Two	SPDT DB ²	Z	1 H.P. 250 VAC
							Heavy Pilot Duty 250 VAC Max.

¹One pole of these models has an adjustable actuating mechanism that enables you to make or break one pole before the other. EXAMPLE: You can break the N.O. Circuit long before you would remake a N.C. Circuit in a 511-B2.

²DB Double Break models must be wired to equal voltage sources and the same polarity. The loads should be on the same sides of the line.

Hercules Anti-Trip - Gated O Shield



NEMA Type 2, 4 & 13
UL ENCLOSURE 2, 4 & 13
CSA ENCLOSURE 2, 4 & 13
EN 60529 Degree of Protection IP56

Drip tight • Dust tight • Watertight • Oil tight
ADVANCED DESIGN HELPS PREVENT ACCIDENTAL ACTUATION

Materials of Construction:

- Treadle and housing constructed from cast iron for strength and durability
- Protected by a strong cast aluminum Shield
- Special AirVal models available to the O.E.M. on special order
- Painted Alert Orange
- Single 3/4"-14 N.P.T. threaded conduit entry is standard

Features & Benefits:

- Heavy duty foot switch features an anti-trip treadle mechanism that helps prevent accidental actuation through unintentional stepping on foot treadle
- Switch operation requires that the latch trip lever be released prior to depressing the foot treadle as in-line foot pressure is applied to the latch trip lever located at the rear of the foot treadle
- Smooth trip lever release and treadle depression motion results in good rate of operation
- Dual treadle return springs and latching mechanism
- Anti-skid rubber feet and 3 holes for rigid mounting to floor or equipment
- All Models have a neoprene Cover Gasket plus O-Rings on the Actuating shaft and separate ground screw

Options:

- Oversize "O" and "OX" Shield models accept oversized safety shoes and metatarsal foot guards. The "OX" Shield has an additional 3/4" (19.1 mm) opening height as compared to the "O" shield
- Special Dual 1/2"-14 N.P.T. threaded conduit entry and metric sizes available to the O.E.M. on special order
- Special Twin & Triple models available to the O.E.M. on special order
- RF Wireless models are available (See "RF Wireless Hercules" on page 83 for details)



SIZE (HxWxD):	5.38 x 6.00 x 9.13 In.
WEIGHT:	8.50 lbs.

For Dimension Drawings visit www.linemaster.com and click on Line Drawings located under the Guides & Literature Tab

⚠ WARNING SEE PRODUCT WARNING ON PAGE 103							
SPECIFICATIONS (Special variations are available to the O.E.M. on special order on the models listed below)							
AGENCY APPROVALS	EN 60529 Degree of Protection	CATALOG NUMBER	DESCRIPTION	STAGE	CIRCUIT	FORM	ELECTRICAL RATINGS
UL, UL, SF	IP56	511-BG	Momentary	Single	SPDT	C	20 A 125-250 VAC
UL, UL, SF	IP56	511-B2G ¹	Momentary	Single	DPDT	C	1 H.P. 125-250 VAC
UL, UL, SF	IP56	511-B2GA	Momentary	Two	SPDT	C	Heavy Pilot Duty 250 VAC Max.
UL, SF	IP56	511-B3G	Momentary	Single	SPDT DB ²	Z	15 A 125-250 VAC
UL, SF	IP56	511-B4G ¹	Momentary	Single	DPDT DB ²	Z	1/2 H.P. 125 VAC
UL, SF	IP56	511-B4GA	Momentary	Two	SPDT DB ²	Z	1 H.P. 250 VAC
							Heavy Pilot Duty 250 VAC Max.

¹One pole of these models has an adjustable actuating mechanism that enables you to make or break one pole before the other. EXAMPLE: You can break the N.O. Circuit long before you would remake a N.C. Circuit in a 511-B2.
²DB Double Break models must be wired to equal voltage sources and the same polarity. The loads should be on the same sides of the line.



Hercules Anti-Trip - Gated OX Shield

**NEMA Type 2, 4 & 13
UL ENCLOSURE 2, 4 & 13
CSA ENCLOSURE 2, 4 & 13
EN 60529 Degree of Protection IP56**

Drip tight • Dust tight • Watertight • Oil tight
ADVANCED DESIGN HELPS PREVENT ACCIDENTAL ACTUATION

Materials of Construction:

- Treadle and housing constructed from cast iron for strength and durability
- Protected by a strong cast aluminum Shield
- Special AirVal models available to the O.E.M. on special order
- Painted Alert Orange
- Single 3/4"-14 N.P.T. threaded conduit entry is standard

Features & Benefits:

- Heavy duty foot switch features an anti-trip treadle mechanism that helps prevent accidental actuation through unintentional stepping on foot treadle
- Switch operation requires that the latch trip lever be released prior to depressing the foot treadle as in-line foot pressure is applied to the latch trip lever located at the rear of the foot treadle
- Smooth trip lever release and treadle depression motion results in good rate of operation
- Dual treadle return springs and latching mechanism
- Anti-skid rubber feet and 3 holes for rigid mounting to floor or equipment
- All Models have a neoprene Cover Gasket plus O-Rings on the Actuating shaft and separate ground screw

Options:

- Oversize "O" and "OX" Shield models accept oversized safety shoes and metatarsal foot guards. The "OX" Shield has an additional 3/4" (19.1 mm) opening height as compared to the "O" shield
- Special Dual 1/2"-14 N.P.T. threaded conduit entry and metric sizes available to the O.E.M. on special order
- Special Twin & Triple models available to the O.E.M. on special order
- RF Wireless models are available (See "RF Wireless Hercules" on page 83 for details)



SIZE (HxWxD):	6.06 x 6.03 x 9.13 In.
WEIGHT:	9.00 lbs.

For Dimension Drawings visit www.linemaster.com and click on Line Drawings located under the Guides & Literature Tab

⚠ WARNING SEE PRODUCT WARNING ON PAGE 103							
SPECIFICATIONS (Special variations are available to the O.E.M. on special order on the models listed below)							
AGENCY APPROVALS	EN 60529 Degree of Protection	CATALOG NUMBER	DESCRIPTION	STAGE	CIRCUIT	FORM	ELECTRICAL RATINGS
UL, IEC	IP56	511-BOXG	Momentary	Single	SPDT	C	20 A 125-250 VAC
UL, IEC	IP56	511-B2OXG ¹	Momentary	Single	DPDT	C	1 H.P. 125-250 VAC
UL, IEC	IP56	511-B2OXGA	Momentary	Two	SPDT	C	Heavy Pilot Duty 250 VAC Max.
UL, IEC	IP56	511-B3OXG	Momentary	Single	SPDT DB ²	Z	15 A 125-250 VAC
UL, IEC	IP56	511-B4OXG ¹	Momentary	Single	DPDT DB ²	Z	1/2 H.P. 125 VAC
UL, IEC	IP56	511-B4OXGA	Momentary	Two	SPDT DB ²	Z	1 H.P. 250 VAC
							Heavy Pilot Duty 250 VAC Max.

¹One pole of these models has an adjustable actuating mechanism that enables you to make or break one pole before the other. EXAMPLE: You can break the N.O. Circuit long before you would remake a N.C. Circuit in a 511-B2.
²DB Double Break models must be wired to equal voltage sources and the same polarity. The loads should be on the same sides of the line.

**NEMA Type 2, 4 & 13
UL ENCLOSURE 2, 4 & 13
CSA ENCLOSURE 2, 4 & 13
EN 60529 Degree of Protection IP56**

**Drip tight • Dust tight • Watertight • Oil tight
NO SHIELD**



Materials of Construction:

- Treadle, cover and housing constructed from cast iron for strength and durability
- Painted Alert Orange
- Single 3/4"-14 N.P.T. threaded conduit entry is standard

Features & Benefits:

- Rugged cast metal enclosure has sufficient weight to keep the switch from sliding when being operated
- All models have a neoprene cover gasket plus O-rings on the activating shaft and a separate ground screw
- In all Maintained Contact models the release is accomplished by simply pressing the latch with a light forward movement of the toe. The release is placed under the Full Shield so falling objects cannot easily release it
- 3 holes provided for rigid mounting to the floor or equipment

Options:

- Oversize "O" and "OX" Shield models accept oversized safety shoes and metatarsal foot guards. The "OX" Shield has an additional 3/4" (19.1 mm) opening height as compared to the "O" shield
- Special Dual 1/2"-14 N.P.T. threaded conduit entry and metric sizes available to the O.E.M. on special order
- Special Twin & Triple models available to the O.E.M. on special order
- Potentiometer models are available (See "Hercules -Potentiometer" on pages 76-79 for details)
- RF Wireless models are available (See "RF Wireless Hercules" on page 83 for details)
- Hercules models available with cast aluminum base and covers (except unshielded cover which is gray iron)

Size (HxWxD):	3.16 x 4.06 x 8.38 In.	<i>For Dimension Drawings visit www.linemaster.com and click on Line Drawings located under the Guides & Literature Tab</i>
Weight:	7.00 lbs.	

⚠ WARNING SEE PRODUCT WARNING ON PAGE 103							
SPECIFICATIONS (Special variations are available to the O.E.M. on special order on the models listed below)							
AGENCY APPROVALS	EN 60529 Degree of Protection	CATALOG NUMBER	DESCRIPTION	STAGE	CIRCUIT	FORM	ELECTRICAL RATINGS
	IP56	531-SWN	Momentary	Single	SPDT	C	20 A 125-250 VAC 1 H.P. 125-250 VAC Heavy Pilot Duty 250 VAC Max.
	IP56	571-DWN	Maintained	Single	SPDT	C	
	IP56	532-SWN	Momentary	Single	DPDT	C	
	IP56	572-DWN	Maintained	Single	DPDT	C	
	IP56	533-SWN	Momentary	Single	TPDT	C	
	IP56	573-DWN	Maintained	Single	TPDT	C	
	IP56	534-SWN	Momentary	Two	SPDT	C	
	IP56	574-DWN	Maintained	Two	SPDT	C	
	IP56	535-SWN	Momentary	Three	SPDT	C	
	IP56	575-DWN	Maintained	Three	SPDT	C	
	IP56	536-SWN	Momentary	Single	SPDT DB ¹	Z	15 A 125-250 VAC 1/2 H.P. 125 VAC 1 H.P. 250 VAC Heavy Pilot Duty 250 VAC Max.
	IP56	576-DWN	Maintained	Single	SPDT DB ¹	Z	
	IP56	537-SWN	Momentary	Single	DPDT DB ¹	Z	
	IP56	577-DWN	Maintained	Single	DPDT DB ¹	Z	
	IP56	538-SWN	Momentary	Two	SPDT DB ¹	Z	
	IP56	578-DWN	Maintained	Two	SPDT DB ¹	Z	

¹DB Double Break models must be wired to equal voltage sources and the same polarity. The loads should be on the same sides of the line.

NEMA Type 2, 4 & 13
UL ENCLOSURE 2, 4 & 13
CSA ENCLOSURE 2, 4 & 13
EN 60529 Degree of Protection IP56

Drip tight • Dust tight • Watertight • Oil tight
STANDARD FULL SHIELD

Materials of Construction:

- Treadle and housing constructed from cast iron for strength and durability
- Protected by a strong cast aluminum Shield
- Painted Alert Orange
- Single 3/4"-14 N.P.T. threaded conduit entry is standard

Features & Benefits:

- Rugged cast metal enclosure has sufficient weight to keep the switch from sliding when being operated
- All models have a neoprene cover gasket plus O-rings on the activating shaft and a separate ground screw
- In all Maintained Contact models the release is accomplished by simply pressing the latch with a light forward movement of the toe. The release is placed under the Full Shield so falling objects cannot easily release it
- 3 holes provided for rigid mounting to the floor or equipment

Options:

- Oversize "O" and "OX" Shield models accept oversized safety shoes and metatarsal foot guards. The "OX" Shield has an additional 3/4" (19.1 mm) opening height as compared to the "O" shield
- Dual 1/2"-14 N.P.T. threaded conduit entry and metric sizes available to the O.E.M. on special order
- Special Twin & Triple models available to the O.E.M. on special order
- AirVal models are available (See "Hercules - Pneumatic AirVal" on page 67 for details)
- Potentiometer models are available (See "Hercules -Potentiometer" on pages 76-79 for details)
- RF Wireless models are available (See "RF Wireless Hercules" on page 83 for details)
- Hercules models available with cast aluminum base & covers (except unshielded cover which is gray iron)



Size (HxWxD):	4.37 x 5.88 x 9.00 In.	<i>For Dimension Drawings visit www.linemaster.com and click on Line Drawings located under the Guides & Literature Tab</i>
Weight:	7.50 lbs.	

⚠ WARNING SEE PRODUCT WARNING ON PAGE 103

SPECIFICATIONS (Special variations are available to the O.E.M. on special order on the models listed below)

AGENCY APPROVALS	EN 60529 Degree of Protection	CATALOG NUMBER	DESCRIPTION	STAGE	CIRCUIT	FORM	ELECTRICAL RATINGS
	IP56	531-SWH	Momentary	Single	SPDT	C	20 A 125-250 VAC 1 H.P. 125-250 VAC Heavy Pilot Duty 250 VAC Max.
	IP56	531-SWHC2 ⁵	Momentary	Single	SPDT	C	
	IP56	571-DWH	Maintained	Single	SPDT	C	
	IP56	532-SWH	Momentary	Single	DPDT	C	
	IP56	572-DWH	Maintained	Single	DPDT	C	
	IP56	533-SWH	Momentary	Single	TPDT	C	
	IP56	533-SWHC2 ⁵	Momentary	Single	TPDT	C	
	IP56	573-DWH	Maintained	Single	TPDT	C	
	IP56	573-DWHC2 ⁵	Maintained	Single	TPDT	C	
	IP56	534-SWH	Momentary	Two	SPDT	C	
	IP56	574-DWH	Maintained	Two	SPDT	C	
	IP56	574-DWHA ¹	See Foot Note	Two	SPDT	C	
	IP56	574-DWHD ²	See Foot Note	Two	SPDT	C	
	IP56	535-SWH	Momentary	Three	SPDT	C	
	IP56	575-DWH	Maintained	Three	SPDT	C	
	IP56	575-DWHA ³	See Foot Note	Three	SPDT	C	
	IP56	536-SWH	Momentary	Single	SPDT DB ⁴	Z	15 A 125-250 VAC 1/2 H.P. 125 VAC 1 H.P. 250 VAC Heavy Pilot Duty 250 VAC Max.
	IP56	576-DWH	Maintained	Single	SPDT DB ⁴	Z	
	IP56	537-SWH	Momentary	Single	DPDT DB ⁴	Z	
	IP56	577-DWH	Maintained	Single	DPDT DB ⁴	Z	
	IP56	538-SWH	Momentary	Two	SPDT DB ⁴	Z	
	IP56	578-DWH	Maintained	Two	SPDT DB ⁴	Z	
	IP56	578-DWHA ¹	See Foot Note	Two	SPDT DB ⁴	Z	
	IP56	578-DWHD ²	See Foot Note	Two	SPDT DB ⁴	Z	

¹1st stage Maintained 2nd stage Momentary. ²1st stage Momentary 2nd stage Maintained. ³1st stage Maintained 2nd & 3rd stage Momentary. ⁴DB Double Break models must be wired to equal voltage sources and the same polarity. The loads should be on the same sides of the line. ⁵"C2" designates dual 1/2" NPT conduit entry.

NEMA Type 2, 4 & 13
UL ENCLOSURE 2, 4 & 13
CSA ENCLOSURE 2, 4 & 13
EN 60529 Degree of Protection IP56

Drip tight • Dust tight • Watertight • Oil tight
“O” SHIELD

Materials of Construction:

- Treadle and housing constructed from cast iron for strength and durability
- Protected by a strong cast aluminum Shield
- Painted Alert Orange
- Single 3/4"-14 N.P.T. threaded conduit entry is standard

Features & Benefits:

- Rugged cast metal enclosure has sufficient weight to keep the switch from sliding when being operated
- All models have a neoprene cover gasket plus O-rings on the activating shaft and a separate ground screw
- In all Maintained Contact models the release is accomplished by simply pressing the latch with a light forward movement of the toe. The release is placed under the Full Shield so falling objects cannot easily release it
- 3 holes provided for rigid mounting to the floor or equipment

Options:

- Oversize “O” and “OX” Shield models accept oversized safety shoes and metatarsal foot guards. The “OX” Shield has an additional 3/4” (19.1 mm) opening height as compared to the “O” shield
- Special Dual 1/2”-14 N.P.T. threaded conduit entry and metric sizes available to the O.E.M. on special order
- Special Twin & Triple models available to the O.E.M. on special order
- Potentiometer models are available (See “Hercules -Potentiometer” on pages 76-79 for details)
- RF Wireless models are available (See “RF Wireless Hercules” on page 83 for details)
- Hercules models available with cast aluminum base and covers (except unshielded cover which is gray iron)



Size (HxWxD):	5.03 x 5.88 x 9.13 In.	<i>For Dimension Drawings visit www.linemaster.com and click on Line Drawings located under the Guides & Literature Tab</i>
Weight:	8.00 lbs.	

⚠ WARNING SEE PRODUCT WARNING ON PAGE 103

SPECIFICATIONS (Special variations are available to the O.E.M. on special order on the models listed below)

AGENCY APPROVALS	EN 60529 Degree of Protection	CATALOG NUMBER	DESCRIPTION	STAGE	CIRCUIT	FORM	ELECTRICAL RATINGS
UL	IP56	531-SWHO	Momentary	Single	SPDT	C	20 A 125-250 VAC 1 H.P. 125-250 VAC Heavy Pilot Duty 250 VAC Max.
UL	IP56	531-SWHOC ⁵	Momentary	Single	SPDT	C	
UL	IP56	571-DWHO	Maintained	Single	SPDT	C	
UL	IP56	532-SWHO	Momentary	Single	DPDT	C	
UL	IP56	532-SWHOC ⁵	Momentary	Single	DPDT	C	
UL	IP56	572-DWHO	Maintained	Single	DPDT	C	
UL	IP56	533-SWHO	Momentary	Single	TPDT	C	
UL	IP56	573-DWHO	Maintained	Single	TPDT	C	
UL	IP56	534-SWHO	Momentary	Two	SPDT	C	
UL	IP56	574-DWHO	Maintained	Two	SPDT	C	
UL	IP56	574-DWHOA ¹	See Foot Note	Two	SPDT	C	
UL	IP56	574-DWHOD ²	See Foot Note	Two	SPDT	C	
UL	IP56	535-SWHO	Momentary	Three	SPDT	C	
UL	IP56	575-DWHO	Maintained	Three	SPDT	C	
UL	IP56	575-DWHOA ³	See Foot Note	Three	SPDT	C	
UL	IP56	536-SWHO	Momentary	Single	SPDT DB ⁴	Z	15 A 125-250 VAC 1/2 H.P. 125 VAC 1 H.P. 250 VAC Heavy Pilot Duty 250 VAC Max.
UL	IP56	576-DWHO	Maintained	Single	SPDT DB ⁴	Z	
UL	IP56	537-SWHO	Momentary	Single	DPDT DB ⁴	Z	
UL	IP56	577-DWHO	Maintained	Single	DPDT DB ⁴	Z	
UL	IP56	538-SWHO	Momentary	Two	SPDT DB ⁴	Z	
UL	IP56	578-DWHO	Maintained	Two	SPDT DB ⁴	Z	
UL	IP56	578-DWHOA ¹	See Foot Note	Two	SPDT DB ⁴	Z	
UL	IP56	578-DWHOD ²	See Foot Note	Two	SPDT DB ⁴	Z	

¹1st stage Maintained 2nd stage Momentary. ²1st stage Momentary 2nd stage Maintained. ³1st stage Maintained 2nd & 3rd stage Momentary. ⁴DB Double Break models must be wired to equal voltage sources and the same polarity. The loads should be on the same sides of the line. ⁵Dual 1/2” - 14 NPT conduit entries.

NEMA Type 2, 4 & 13
UL ENCLOSURE 2, 4 & 13
CSA ENCLOSURE 2, 4 & 13
EN 60529 Degree of Protection IP56

Drip tight • Dust tight • Watertight • Oil tight
"OX" SHIELD

Materials of Construction:

- Treadle and housing constructed from cast iron for strength and durability
- Protected by a strong cast aluminum Shield
- Painted Alert Orange
- Single 3/4"-14 N.P.T. threaded conduit entry is standard

Features & Benefits:

- Rugged cast metal enclosure has sufficient weight to keep the switch from sliding when being operated
- All models have a neoprene cover gasket plus O-rings on the activating shaft and a separate ground screw
- In all Maintained Contact models the release is accomplished by simply pressing the latch with a light forward movement of the toe. The release is placed under the Full Shield so falling objects cannot easily release it
- 3 holes provided for rigid mounting to the floor or equipment

Options:

- Oversize "O" and "OX" Shield models accept oversized safety shoes and metatarsal foot guards. The "OX" Shield has an additional 3/4" (19.1 mm) opening height as compared to the "O" shield
- Special Dual 1/2"-14 N.P.T. threaded conduit entry and metric sizes available to the O.E.M. on special order
- Special Twin & Triple models available to the O.E.M. on special order
- Potentiometer models are available (See "Hercules -Potentiometer" on pages 76-79 for details)
- RF Wireless models are available (See "RF Wireless Hercules" on page 83 for details)
- Hercules models available with cast aluminum base and covers (except unshielded cover which is gray iron)



Size (HxWxD):	5.78 x 6.03 x 9.13 In.	<i>For Dimension Drawings visit www.linemaster.com and click on Line Drawings located under the Guides & Literature Tab</i>
Weight:	8.50 lbs.	

⚠ WARNING SEE PRODUCT WARNING ON PAGE 103							
SPECIFICATIONS (Special variations are available to the O.E.M. on special order on the models listed below)							
AGENCY APPROVALS	EN 60529 Degree of Protection	CATALOG NUMBER	DESCRIPTION	STAGE	CIRCUIT	FORM	ELECTRICAL RATINGS
	IP56	531-SWFOX	Momentary	Single	SPDT	C	20 A 125-250 VAC 1 H.P. 125-250 VAC Heavy Pilot Duty 250 VAC Max.
	IP56	571-DWFOX	Maintained	Single	SPDT	C	
	IP56	532-SWFOX	Momentary	Single	DPDT	C	
	IP56	572-DWFOX	Maintained	Single	DPDT	C	
	IP56	533-SWFOX	Momentary	Single	TPDT	C	
	IP56	573-DWFOX	Maintained	Single	TPDT	C	
	IP56	534-SWFOX	Momentary	Two	SPDT	C	
	IP56	574-DWFOX	Maintained	Two	SPDT	C	
	IP56	574-DWFOXA ¹	<i>See Foot Note</i>	Two	SPDT	C	
	IP56	574-DWFOX ²	<i>See Foot Note</i>	Two	SPDT	C	
	IP56	535-SWFOX	Momentary	Three	SPDT	C	
	IP56	575-DWFOX	Maintained	Three	SPDT	C	
	IP56	575-DWFOXA ³	<i>See Foot Note</i>	Three	SPDT	C	
	IP56	536-SWFOX	Momentary	Single	SPDT DB ⁴	Z	
	IP56	576-DWFOX	Maintained	Single	SPDT DB ⁴	Z	
	IP56	537-SWFOX	Momentary	Single	DPDT DB ⁴	Z	
	IP56	577-DWFOX	Maintained	Single	DPDT DB ⁴	Z	
	IP56	538-SWFOX	Momentary	Two	SPDT DB ⁴	Z	
	IP56	578-DWFOX	Maintained	Two	SPDT DB ⁴	Z	
	IP56	578-DWFOXA ¹	<i>See Foot Note</i>	Two	SPDT DB ⁴	Z	
	IP56	578-DWFOX ²	<i>See Foot Note</i>	Two	SPDT DB ⁴	Z	

¹1st stage Maintained 2nd stage Momentary. ²1st stage Momentary 2nd stage Maintained. ³1st stage Maintained 2nd & 3rd stage Momentary. ⁴DB Double Break models must be wired to equal voltage sources and the same polarity. The loads should be on the same sides of the line.

NEMA Type 1, 2, 4, 6, 6P & 13
UL ENCLOSURE 1, 2, 4, 6, 6P & 13
EN 60529 Degree of Protection IP68
IEC 60601-2-2

Drip tight • Dust tight • Watertight • Oil tight
DEVELOPED FOR WORLDWIDE APPLICATIONS

Materials of Construction:

- Treadle and housing constructed from cast aluminum for environmental durability
- Painted Alert Orange
- Single PG 16 threaded conduit entry is standard

Features & Benefits:

- Protected by a strong cast iron cover
- Developed for worldwide application
- Snap action - SPDT and DPDT with forced disconnect (positive break) on NC contacts
- Slow action mechanism with forced disconnect on the NC contacts - available as SPDT make before break or break before make
- Direct PLC interface compatible (two-circuit bifurcated contact single-pole versions)
- Galvanically isolated bifurcated contacts - NO and NC circuits can be wired to different loads and polarities
- 3 holes provided for rigid mounting to the floor or equipment

Options:

- Oversize "O" and "OX" Shield models accept oversized safety shoes and metatarsal foot guards. The "OX" Shield has an additional 3/4" (19.1 mm) opening height as compared to the "O" shield
- 3/4-14 N.P.T. also available as standard for select models
- U.S. and other international conduit sizes and side entry available to the OEM on special order
- Side entry PG 16 threaded conduit entry available
- Twin and triple models available - Special Order



Size (HxWxD):	3.50 x 4.29 x 8.55 In.
Weight:	4.50 lbs.

For Dimension Drawings visit www.linemaster.com and click on Line Drawings located under the Guides & Literature Tab

⚠ WARNING SEE PRODUCT WARNING ON PAGE 103						
SPECIFICATIONS (Special variations are available to the O.E.M. on special order on the models listed below)						
AGENCY APPROVALS	EN 60529 Degree of Protection	CATALOG NUMBER	DESCRIPTION	CIRCUIT	FORM	ELECTRICAL RATINGS
	IP68	936-SWN	Momentary	SPDT-SNAP ACTION		A300, Q300: Ith = 10A (AC) Ith = 2.5 A (DC)
	IP68	936-SWNBM ¹	Momentary	SPDT-SLOW ACTION BBM ¹		AC15: Ue = 240V; Ie = 3A
	IP68	936-SWNMB ²	Momentary	SPDT-SLOW ACTION MBB ²		Ue = 120V; Ie = 6A
	IP68	937-SWN	Momentary	DPDT-SNAP ACTION		DC13: Ue = 250V; Ie = 0.27A Ue = 120V; Ie = 0.55A Ue = 24V; Ie = 2.5A

¹Break Before Make ²Make Before Break

NEMA Type 1, 2, 4, 6, 6P & 13
UL ENCLOSURE 1, 2, 4, 6, 6P & 13
EN 60529 Degree of Protection IP68
IEC 60601-2-2



Drip tight • Dust tight • Watertight • Oil tight
DEVELOPED FOR WORLDWIDE APPLICATIONS

Materials of Construction:

- Treadle and housing constructed from cast aluminum for environmental durability
- Painted Alert Orange
- Single PG 16 threaded conduit entry is standard

Features & Benefits:

- Protected by a strong cast aluminum Shield
- Developed for worldwide application
- Snap action - SPDT and DPDT with forced disconnect (positive break) on NC contacts
- Slow action mechanism with forced disconnect on the NC contacts - available as SPDT make before break or break before make
- Direct PLC interface compatible (two-circuit bifurcated contact single-pole versions)
- Galvanically isolated bifurcated contacts - NO and NC circuits can be wired to different loads and polarities
- 3 holes provided for rigid mounting to the floor or equipment

Options:

- Oversize "O" and "OX" Shield models accept oversized safety shoes and metatarsal foot guards. The "OX" Shield has an additional 3/4" (19.1 mm) opening height as compared to the "O" shield
- 3/4-14 N.P.T. also available as standard for select models
- U.S. and other international conduit sizes and side entry available to the OEM on special order
- Side entry PG 16 threaded conduit entry available
- Twin and triple models available - Special Order

Size (HxWxD):	4.70 x 5.88 x 9.06 In.
Weight:	5.00 lbs.

For Dimension Drawings visit www.linemaster.com and click on Line Drawings located under the Guides & Literature Tab

⚠ WARNING SEE PRODUCT WARNING ON PAGE 103						
SPECIFICATIONS (Special variations are available to the O.E.M. on special order on the models listed below)						
AGENCY APPROVALS	EN 60529 Degree of Protection	CATALOG NUMBER	DESCRIPTION	CIRCUIT	FORM	ELECTRICAL RATINGS
cULus CE	IP68	936-SWH	Momentary	SPDT-SNAP ACTION		A300, Q300:
cULus CE	IP68	936-SWHC4 ¹	Momentary	SPDT-SNAP ACTION		Ith = 10A (AC) Ith = 2.5 A (DC)
cULus CE	IP68	936-SWHBM ²	Momentary	SPDT-SLOW ACTION BBM ²		AC15: Ue = 240V; Ie = 3A
cULus CE	IP68	936-SWHMB ³	Momentary	SPDT-SLOW ACTION MBB ³		Ue = 120V; Ie = 6A
cULus CE	IP68	937-SWH	Momentary	DPDT-SNAP ACTION		DC13: Ue = 250V; Ie = 0.27A Ue = 120V; Ie = 0.55A
cULus CE	IP68	937-SWHC4 ¹	Momentary	DPDT-SNAP ACTION		Ue = 24V; Ie = 2.5A

¹"C4" designates a single 3/4"-14 NPT conduit entry ²Break Before Make ³Make Before Break

NEMA Type 1, 2, 4, 6, 6P & 13
UL ENCLOSURE 1, 2, 4, 6, 6P & 13
EN 60529 Degree of Protection IP68
IEC 60601-2-2

Drip tight • Dust tight • Watertight • Oil tight
DEVELOPED FOR WORLDWIDE APPLICATIONS

Materials of Construction:

- Treadle and housing constructed from cast aluminum for environmental durability
- Painted Alert Orange
- Single PG 16 threaded conduit entry is standard

Features & Benefits:

- Protected by a strong cast aluminum Shield
- Developed for worldwide application
- Snap action - SPDT and DPDT with forced disconnect (positive break) on NC contacts
- Slow action mechanism with forced disconnect on the NC contacts - available as SPDT make before break or break before make
- Direct PLC interface compatible (two-circuit bifurcated contact single-pole versions)
- Galvanically isolated bifurcated contacts - NO and NC circuits can be wired to different loads and polarities
- 3 holes provided for rigid mounting to the floor or equipment

Options:

- Oversize "O" and "OX" Shield models accept oversized safety shoes and metatarsal foot guards. The "OX" Shield has an additional 3/4" (19.1 mm) opening height as compared to the "O" shield
- 3/4-14 N.P.T. also available as standard for select models
- U.S. and other international conduit sizes and side entry available to the OEM on special order
- Side entry PG 16 threaded conduit entry available
- Twin and triple models available - Special Order



Size (HxWxD):	5.37 x 5.88 x 9.13 In.
Weight:	5.25 lbs.

For Dimension Drawings visit www.linemaster.com and click on Line Drawings located under the Guides & Literature Tab

⚠ WARNING SEE PRODUCT WARNING ON PAGE 103						
SPECIFICATIONS (Special variations are available to the O.E.M. on special order on the models listed below)						
AGENCY APPROVALS	EN 60529 Degree of Protection	CATALOG NUMBER	DESCRIPTION	CIRCUIT	FORM	ELECTRICAL RATINGS
	IP68	936-SWHO	Momentary	SPDT-SNAP ACTION		A300, Q300: Ith = 10A (AC) Ith = 2.5 A (DC)
	IP68	936-SWHOBM ¹	Momentary	SPDT-SLOW ACTION BBM ¹		AC15: Ue = 240V; Ie = 3A Ue = 120V; Ie = 6A
	IP68	936-SWHOMB ²	Momentary	SPDT-SLOW ACTION MBB ²		DC13: Ue = 250V; Ie = 0.27A Ue = 120V; Ie = 0.55A
	IP68	937-SWHO	Momentary	DPDT-SNAP ACTION		Ue = 24V; Ie = 2.5A
	IP68	937-SWHOC ³	Momentary	DPDT-SNAP ACTION		

¹Break Before Make ²Make Before Break ³"C4" designates a single 3/4"-14 NPT conduit entry

NEMA Type 1, 2, 4, 6, 6P & 13
UL ENCLOSURE 1, 2, 4, 6, 6P & 13
EN 60529 Degree of Protection IP68
IEC 60601-2-2



Drip tight • Dust tight • Watertight • Oil tight
DEVELOPED FOR WORLDWIDE APPLICATIONS

Materials of Construction:

- Treadle and housing constructed from cast aluminum for environmental durability
- Painted Alert Orange
- Single PG 16 threaded conduit entry is standard

Features & Benefits:

- Protected by a strong cast aluminum Shield
- Developed for worldwide application
- Snap action - SPDT and DPDT with forced disconnect (positive break) on NC contacts
- Slow action mechanism with forced disconnect on the NC contacts - available as SPDT make before break or break before make
- Direct PLC interface compatible (two-circuit bifurcated contact single-pole versions)
- Galvanically isolated bifurcated contacts - NO and NC circuits can be wired to different loads and polarities
- 3 holes provided for rigid mounting to the floor or equipment

Options:

- Oversize "O" and "OX" Shield models accept oversized safety shoes and metatarsal foot guards. The "OX" Shield has an additional 3/4" (19.1 mm) opening height as compared to the "O" shield
- 3/4-14 N.P.T. also available as standard for select models
- U.S. and other international conduit sizes and side entry available to the OEM on special order
- Side entry PG 16 threaded conduit entry available
- Twin and triple models available - Special Order

Size (HxWxD):	6.12 x 6.03 x 9.13 In.
Weight:	5.50 lbs.
<p><i>For Dimension Drawings visit www.linemaster.com and click on Line Drawings located under the Guides & Literature Tab</i></p>	

⚠ WARNING SEE PRODUCT WARNING ON PAGE 103						
SPECIFICATIONS (Special variations are available to the O.E.M. on special order on the models listed below)						
AGENCY APPROVALS	EN 60529 Degree of Protection	CATALOG NUMBER	DESCRIPTION	CIRCUIT	FORM	ELECTRICAL RATINGS
	IP68	936-SWHOX	Momentary	SPDT-SNAP ACTION		A300, Q300: Ith = 10A (AC) Ith = 2.5 A (DC) AC15: Ue = 240V; Ie = 3A Ue = 120V; Ie = 6A DC13: Ue = 250V; Ie = 0.27A Ue = 120V; Ie = 0.55A Ue = 24V; Ie = 2.5A
	IP68	936-SWHOXC ³	Momentary	SPDT-SNAP ACTION		
	IP68	936-SWHOXBM ¹	Momentary	SPDT-SLOW ACTION BBM ¹		
	IP68	936-SWHOXMB ²	Momentary	SPDT-SLOW ACTION MBB ²		
	IP68	937-SWHOX	Momentary	DPDT-SNAP ACTION		
	IP68	937-SWHOXC ³	Momentary	DPDT-SNAP ACTION		

¹Break Before Make ²Make Before Break ³"C4" designates a single 3/4"-14 NPT conduit entry

CLASS I, DIVISION 1, Group D
CLASS II, DIVISION 1, Group F & G
CLASS I, ZONE 1, GROUP IIA
NEMA Type 2, 7D & 9F
UL ENCLOSURE 2
EN 60529 Degree of Protection IP41

EQUIPMENT FOR HAZARDOUS LOCATIONS

Materials of Construction:

- Aluminum full guard with integral base plate painted Alert Orange
- All models supplied with a 3/4"-14 N.P.T. threaded rigid metal conduit entry and mounting provisions in the base plate
- Integral handle for ease of moving

Features & Benefits:

- Non sparking cast aluminum housing
- 4 holes provided for rigid mounting to floor or equipment
- The two pedal model is supplied with a divider bar between pedals which helps prevent accidental operation of both pedals at one time

Options:

- Waterproof model available under "600 Series" (See "Explosion Proof - Industrial 600" on page 35 for details)
- Medical Explosion-proof models available (See "Explosion Proof - Medical..." on pages 36 & 37 for details)



Size (HxWxD):	4.38 x 11.00 x 10.25 In.
Weight:	8.75 lbs.

For Dimension Drawings visit www.linemaster.com and click on Line Drawings located under the Guides & Literature Tab

⚠ WARNING SEE PRODUCT WARNING ON PAGE 103						
SPECIFICATIONS (Special variations are available to the O.E.M. on special order on the models listed below)						
AGENCY APPROVALS	EN 60529 Degree of Protection	CATALOG NUMBER	DESCRIPTION	CIRCUIT	FORM	ELECTRICAL RATINGS
cULus	IP41	592-EX	Single Pedal / Momentary	SPDT	C	15 A 125 VAC 10 A 250 VAC
cULus	IP41	594-EX	Single Pedal / Momentary	DPDT	C	3/4 H.P. 125 VAC 1 H.P. 250 VAC
cULus	IP41	597-EX	Two Pedal / Momentary	Each Pedal SPDT	C	3 A 28 VDC Heavy Pilot Duty 250 VAC Max.

CLASS I, DIVISION 1, Group D
CLASS II, DIVISION 1, Group F & G
CLASS I, ZONE 1, GROUP IIA
NEMA Type 2, 3, 4, 6, 6P, 13, 7D & 9F
UL ENCLOSURE 2, 3, 4, 6, 6P, 7, 9 & 13
EN 60529 Degree of Protection IP68
Meets IEC 60601-2-2

Drip tight • Dust tight • Watertight • Oil tight
EQUIPMENT FOR HAZARDOUS LOCATIONS

Materials of Construction:

- Aluminum full guard with integral base plate painted Alert Orange
- Integral handle for ease of moving
- All models supplied with a 3/4"-14 N.P.T. threaded rigid metal conduit entry and mounting provisions in the base plate
- Industrial Explosion Proof foot switch Series 600 offers added environmental protection against water and oil, through the addition of sealing O-rings on the pivot rod and between the cover and base
- This is accomplished by increasing the thickness of the housing walls, without negating the integrity of the metal to metal contact required to qualify as explosion proof

Features & Benefits:

- Non sparking cast aluminum housing
- 4 holes provided for rigid mounting to floor or equipment
- The two pedal model is supplied with a divider bar between pedals which helps prevent accidental operation of both pedals at one time

Options:

- Medical Explosion-proof models available (See "Explosion Proof - Medical..." on pages 36 & 37 for details)



Size (HxWxD):	4.38 x 11.00 x 10.25 In.
Weight:	9.50 lbs.

For Dimension Drawings visit www.linemaster.com and click on Line Drawings located under the Guides & Literature Tab

⚠ WARNING SEE PRODUCT WARNING ON PAGE 103						
SPECIFICATIONS (Special variations are available to the O.E.M. on special order on the models listed below)						
AGENCY APPROVALS	EN 60529 Degree of Protection	CATALOG NUMBER	DESCRIPTION	CIRCUIT	FORM	ELECTRICAL RATINGS
cULus	IP68	602-EX	Single Pedal / Momentary	SPDT	C	15 A 125 VAC 10 A 250 VAC
cULus	IP68	604-EX	Single Pedal / Momentary	DPDT	C	3/4 H.P. 125 VAC 1 H.P. 250 VAC
cULus	IP68	607-EX	Two Pedal / Momentary	Each Pedal SPDT	C	3 A 28 VDC Heavy Pilot Duty 250 VAC Max.

CLASS I, DIVISION 1, Group C & D
CLASS I, ZONE 1, Group IIA & IIB
NEMA Type 7C
EN 60529 Degree of Protection IP41

EQUIPMENT FOR HAZARDOUS LOCATIONS
Not For Use In Industrial Applications

Materials of Construction:

- Aluminum base plate with nonskid conductive rubber base pad
- Both models prewired with potted connector MS-3102R-18-4PW
- Two pedal model wired with an electrical interlock and supplied with a divider bar between pedals which helps prevent accidental operation of both pedals at one time
- Foot switch painted black
- Integral handle for ease of moving

Features & Benefits:

- Non sparking cast aluminum housing
- The two pedal model is supplied with a divider bar between pedals which helps prevent accidental operation of both pedals at one time
- Two pedal models prewired with electrical interlock

Options:

- Use mating connector MS-3106A-18-4SW, plus strain relief clamp MS-3057-10 or 10A
- Mating connector with cable clamp available from LINEMASTER®. Order as Catalog Number LSC-835
- Industrial Explosion-proof models available (See “Explosion Proof - Industrial...” on pages 34 & 35 for details)



Size (HxWxD):	4.38 x 9.75 x 10.00 In.
Weight:	7.50 lbs.

For Dimension Drawings visit www.linemaster.com and click on Line Drawings located under the Guides & Literature Tab

⚠ WARNING SEE PRODUCT WARNING ON PAGE 103							
SPECIFICATIONS (Special variations are available to the O.E.M. on special order on the models listed below)							
AGENCY APPROVALS	EN 60529 Degree of Protection	CATALOG NUMBER	DESCRIPTION	CIRCUIT	FORM	WIRED	ELECTRICAL RATINGS
	IP41	591-EX	Single Pedal / Momentary	SPDT	C	Pin A-Normally Open B-Common C-Normally Closed D-Ground	5 A 125-250 VAC 3 A 28 VDC
	IP41	596-EX	Two Pedal / Momentary	Each Pedal SPNO	A	Pin A-Normally Open (Left Pedal) B-Common C-Normally Open (Right Pedal) D-Ground	

CLASS I, DIVISION 1, Group C & D
CLASS I, ZONE 1, Group IIA & IIB
NEMA Type 7C
EN 60529 Degree of Protection IP68
Meets IEC 60601-2-2

EQUIPMENT FOR HAZARDOUS LOCATIONS
Not For Use In Industrial Applications

Materials of Construction:

- Medical Explosion Proof foot switch Series 600 is a UL Listed construction that allows the addition of sealing O-rings on the pivot rod and between the base and cover
- This is accomplished by increasing the thickness of the housing wall, without negating the integrity of the metal to metal contact required to qualify as explosion proof
- Aluminum baseplate with non-skid conductive rubber basepad
- Footswitch painted black
- Integral handle for ease of moving

Features & Benefits:

- Non sparking cast aluminum housing
- The two pedal model is supplied with a divider bar between pedals which helps prevent accidental operation of both pedals at one time
- Two pedal models prewired with electrical interlock

Options:

- Use mating connector MS or CA-3106F-18-4SW-(A105)-(F74)* which includes cable clamp, or CA-06R-18-4SW-(A105)-(F74)* which includes cable clamp
- Mating connector with cable clamp available from LINEMASTER®. Order as Catalog Number LSC-575-24
- Industrial Explosion-proof models available (See “Explosion Proof - Industrial...” on pages 34 & 35 for details)



Size (HxWxD):	4.38 x 9.75 x 10.00 In.
Weight:	8.00 lbs.

For Dimension Drawings visit www.linemaster.com and click on Line Drawings located under the Guides & Literature Tab

⚠ WARNING SEE PRODUCT WARNING ON PAGE 103							
SPECIFICATIONS (Special variations are available to the O.E.M. on special order on the models listed below)							
AGENCY APPROVALS	EN 60529 Degree of Protection	CATALOG NUMBER	DESCRIPTION	CIRCUIT	FORM	WIRED	ELECTRICAL RATINGS
	IP68	601-EX	Single Pedal / Momentary	SPDT	C	Pin A-Normally Open B-Common C-Normally Closed D-Ground	5 A 125-250 VAC 3 A 28 VDC
	IP68	606-EX	Two Pedal / Momentary	Each Pedal SPNO	A	Pin A-Normally Open (Left Pedal) B-Common C-Normally Open (Right Pedal) D-Ground	

NEMA Type 1, 2, 4, 6, 6P & 13
UL ENCLOSURE 1, 2, 4, 6, 6P & 13
CSA ENCLOSURE 1, 2, 4, 6, 6P & 13
EN 60529 Degree of Protection IP68
Meets IEC 60601-2-2

Drip tight • Dust tight • Watertight • Oil tight
COMPACT & WATERPROOF DESIGN

Materials of Construction:

- One Piece Cast Aluminum Housing Single Stage Momentary Contact
- Aluminum baseplate on unguarded models
- Single Pedal 1/2"-14 N.P.T. Threaded Conduit Opening is Standard
- Twin Pedal 3/4"-14 N.P.T. Threaded Conduit Opening is Standard

Features & Benefits:

- No dead spot in switch actuation
- Hall Effect sensor for high reliability
- Non-Skid Feet To Minimize Movement
- Divider Bar on Twin Models aids in Reducing Accidental Operation of Multiple Pedals at Once
- 4 holes provided for rigid mounting to floor or equipment

Options:

- Up to two pushbutton switches possible
- Mode change switch
- Custom switch colors available
- Custom labeling & silkscreening available
- Protective bag for easy clean-up



Single	
Size (HxWxD):	2.50 x 4.19 x 7.00 In.
Weight:	1.75 lbs.
Twin	
Size (HxWxD):	2.50 x 7.40 x 7.00 In.
Weight:	3.63 lbs.

For Dimension Drawings visit www.linemaster.com and click on Line Drawings located under the Guides & Literature Tab

⚠ WARNING SEE PRODUCT WARNING ON PAGE 103						
SPECIFICATIONS (Special variations are available to the O.E.M. on special order on the models listed below)						
AGENCY APPROVALS	EN 60529 Degree of Protection	CATALOG NUMBER	DESCRIPTION	TYPE	CIRCUIT	ELECTRICAL RATING
	IP68	88LSN1	Momentary	Unguarded	Linear	Input voltage 5-15 VDC (Other voltages available)
	IP68	88LSH1	Momentary	Guarded	Linear	
	IP68	TWIN 88LSN1	Momentary	Unguarded	Each Pedal Linear	
	IP68	TWIN 88LSH1	Momentary	Guarded	Each Pedal Linear	



NEMA Type 1, 2, 4, 6, 6P & 13
UL ENCLOSURE 1, 2, 4, 6, 6P & 13
CSA ENCLOSURE 1, 2, 4, 6, 6P & 13
EN 60529 Degree of Protection IP68
Meets IEC 60601-2-2

Drip tight • Dust tight • Watertight • Oil tight
GUARDED, COMPACT & WATERPROOF DESIGN

Materials of Construction:

- One Piece Cast Aluminum Housing Single Stage Momentary Contact
- Aluminum baseplate on unguarded models
- Single Pedal 1/2"-14 N.P.T. Threaded Conduit Opening is Standard
- Twin Pedal 3/4"-14 N.P.T. Threaded Conduit Opening is Standard

Features & Benefits:

- Non-Skid Feet To Minimize Movement
- Divider Bar on Twin Models aids in Reducing Accidental Operation of Multiple Pedals at Once
- 4 holes provided for rigid mounting to floor or equipment
- Heavy Gauge Steel Full Guard painted Alert Orange Covering Entire Foot Switch

Options:

- Linear (Hall Effect) mode models available (See page 38 for details)



Single	
Size (HxWxD):	4.50 x 6.00 x 7.00 In.
Weight:	6.00 lbs.
Twin	
Size (HxWxD):	4.50 x 11.00 x 7.00 In.
Weight:	10.00 lbs.
For Dimension Drawings visit www.linemaster.com and click on Line Drawings located under the Guides & Literature Tab	

⚠ WARNING SEE PRODUCT WARNING ON PAGE 103							
SPECIFICATIONS (Special variations are available to the O.E.M. on special order on the models listed below)							
AGENCY APPROVALS	EN 60529 Degree of Protection	CATALOG NUMBER	DESCRIPTION	TYPE	CIRCUIT	FORM	ELECTRICAL RATING
UL, CE, C	IP68	88SH1-05	Momentary	Guarded	SPDT	C	16 A 125-250 VAC 1/2 H.P. 125-250 VAC 250 VAC Maximum
UL, CE, C	IP68	88SH2-05	Momentary	Guarded	DPDT	C	
UL, CE, C	IP68	TWIN 88SH1-05	Momentary	Guarded	Each Pedal SPDT	C	
UL, CE, C	IP68	TWIN 88SH2-05	Momentary	Guarded	Each Pedal DPDT	C	

Classic IV - No Guard



NEMA Type 1, 2, 4, 6, 6P & 13
UL ENCLOSURE 1, 2, 4, 6, 6P & 13
CSA ENCLOSURE 1, 2, 4, 6, 6P & 13
EN 60529 Degree of Protection IP68
Meets IEC 60601-2-2

Drip tight • Dust tight • Watertight • Oil tight
COMPACT & WATERPROOF DESIGN

Materials of Construction:

- One Piece Cast Aluminum Housing Single Stage Momentary Contact
- Aluminum baseplate on unguarded models
- Single Pedal 1/2"-14 N.P.T. Threaded Conduit Opening is Standard
- Twin Pedal 3/4"-14 N.P.T. Threaded Conduit Opening is Standard

Features & Benefits:

- Non-Skid Feet To Minimize Movement
- Divider Bar on Twin Models aids in Reducing Accidental Operation of Multiple Pedals at Once
- 4 holes provided for rigid mounting to floor or equipment

Options:

- Linear (Hall Effect) mode models available (See "Classic IV Linear" on page 38 for details)
- Heavy Gauge Steel Full Guard painted Alert Orange
 Covering Entire Foot Switch Available (See "Classic IV - Guarded" on page 39 for details)

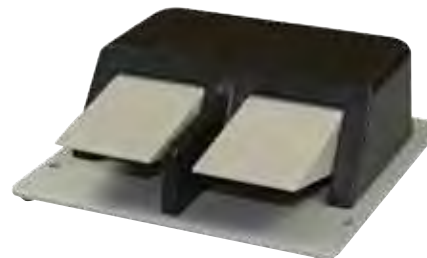

Single	
Size (HxWxD):	2.50 x 4.19 x 7.00 In.
Weight:	1.75 lbs.
Twin	
Size (HxWxD):	2.50 x 7.40 x 7.00 In.
Weight:	3.63 lbs.

For Dimension Drawings visit www.linemaster.com and click on Line Drawings located under the Guides & Literature Tab

▲ WARNING SEE PRODUCT WARNING ON PAGE 103							
SPECIFICATIONS (Special variations are available to the O.E.M. on special order on the models listed below)							
AGENCY APPROVALS	EN 60529 Degree of Protection	CATALOG NUMBER	DESCRIPTION	TYPE	CIRCUIT	FORM	ELECTRICAL RATING
UL, SP, CE	IP68	88SN1-05	Momentary	Unguarded	SPDT	C	16 A 125-250 VAC 1/2 H.P. 125-250 VAC 250 VAC Maximum
UL, SP, CE	IP68	88SN1B-05 ¹	Momentary	Unguarded	SPDT	C	
UL, SP, CE	IP68	88SN2-05	Momentary	Unguarded	DPDT	C	
UL, SP, CE	IP68	TWIN 88SN1-05	Momentary	Unguarded	Each Pedal SPDT	C	
UL, SP, CE	IP68	TWIN 88SN2-05	Momentary	Unguarded	Each Pedal DPDT	C	

¹8 ft. 14/3 cord without plug, green lead grounded.

NEMA Type 1, 2, 4 & 13
UL ENCLOSURE 1, 2, 4 & 13
CSA ENCLOSURE 1, 2, 4 & 13
EN 60529 Degree of Protection IP56

Drip tight • Dust tight • Watertight • Oil tight
MEDIUM DUTY COMPACT DESIGN

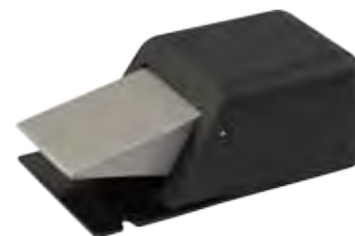

Materials of Construction:

- Cast aluminum body and treadle with steel base plate and nonskid base pad
- Single 3/4"-14 N.P.T. threaded conduit entry is standard

Features & Benefits:

- All models single stage momentary contact
- 2 holes provided for rigid mounting to floor or equipment

Options:

- Special threaded conduit entry available to the O.E.M. on special order (Dual / Metric)
- Single/Dual 1/2"-14 NPT threaded conduit entry
- Metric threaded conduit entry

No Shield	
Size (HxWxD):	2.25 In. x 3.50 x 6.20 In.
Weight:	1.50 lbs.
Shielded	
Size (HxWxD):	5.19 In. x 5.90 x 7.27 In.
Weight:	2.75 lbs.
<i>For Dimension Drawings visit www.linemaster.com and click on Line Drawings located under the Guides & Literature Tab</i>	

⚠ WARNING SEE PRODUCT WARNING ON PAGE 103						
SPECIFICATIONS (Special variations are available to the O.E.M. on special order on the models listed below)						
AGENCY APPROVALS	EN 60529 Degree of Protection	CATALOG NUMBER	DESCRIPTION	CIRCUIT	FORM	ELECTRICAL RATINGS
	IP56	78SN1	Momentary	SPDT	C	20 A 125-250 VAC 1 H.P. 125-250 VAC Heavy Pilot Duty 250 VAC Max.
	IP56	78SN2	Momentary	DPDT	C	
	IP56	78SH1	Momentary / Shielded	SPDT	C	
	IP56	78SH2	Momentary / Shielded	DPDT	C	

EN 60529 Degree of Protection IP20 (IP68 Upon Request)

COMPACT DESIGN

Materials of Construction:

- Cast aluminum body painted black
- Cast aluminum treadle and base plate with nonskid base pad
- Internal strain relief clamp accepts a wide range of cable sizes

Features & Benefits:

- Single stage momentary contact
- Clean lines and compact design with a modest cost
- Versatility of this model makes it ideal for O.E.M. devices

Options:

- Special threaded conduit entry available to the O.E.M. on special order. (Dual / Metric)
- Custom cordsets and modifications are available to the O.E.M. on special order
- Also available in Solid State (Hall Effect) format on special order. Contact office for specifications
- AirVal models available (See "Classic - Pneumatic AirVal" on page 71 for details)
- Heavy gauge steel guard available (See "Accessories - Guards" on pages 94 & 95 for details)

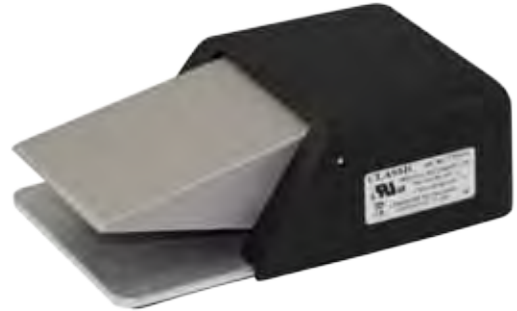

Size (HxWxD):	1.68 x 3.25 x 5.39 In.
Weight:	1.13 lbs.

For Dimension Drawings visit www.linemaster.com and click on Line Drawings located under the Guides & Literature Tab

⚠ WARNING SEE PRODUCT WARNING ON PAGE 103 SPECIFICATIONS (Special variations are available to the O.E.M. on special order on the models listed below)						
AGENCY APPROVALS	EN 60529 Degree of Protection	CATALOG NUMBER	DESCRIPTION	CIRCUIT	FORM	ELECTRICAL RATINGS
	IP20	77SN1	Momentary	SPDT	C	15 A 125-250 VAC 1/2 H.P. 125-250 VAC

EN 60529 Degree of Protection IP20 (IP68 Upon Request)

LOW POWER COMPACT DESIGN

Materials of Construction:

- Cast aluminum body painted black
- Cast aluminum treadle and base plate with nonskid base pad
- Internal strain relief clamp accepts a wide range of cable sizes

Features & Benefits:

- Single stage momentary contact
- Versatility of this model makes it ideal for O.E.M. devices
- Clean lines and compact design with a modest cost

Options:

- Custom cordsets and modifications are available to the O.E.M. on special order.
- Also available in Solid State (Hall Effect) format on special order. Contact office for specifications
- Heavy gauge steel guard available (See "Accessories - Guards" on pages 94 & 95 for details)

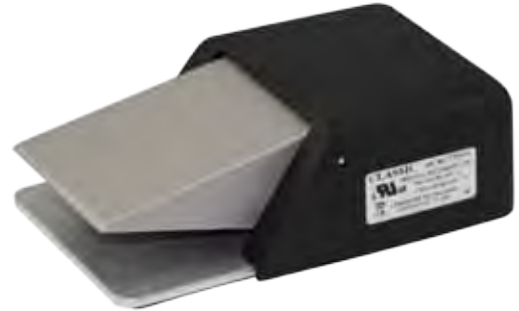

⚠ WARNING THE CLASSIC REED IS A LOW POWER DEVICE AND MUST BE USED ONLY IN THOSE APPLICATIONS WHERE SUITABLE DESIGN CONSTRAINTS AND SAFETY PRECAUTIONS ARE MET. CONTACT PROTECTION IS RECOMMENDED IF INDUCTIVE OR HIGH VOLTAGE LOADS ARE SWITCHED. PROPER SNUBBER NETWORKS ARE REQUIRED. HIGH INRUSH CURRENT, DAMAGING TO THE CONTACTS MAY BE PRESENT WHEN SWITCHING TUNGSTEN FILAMENT BULBS OR THROUGH WIRE OF SUFFICIENT LENGTH TO INTRODUCE STORED CAPACITANCE.

Size (HxWxD):	1.68 x 3.25 x 5.39 In.
Weight:	1.13 lbs.

For Dimension Drawings visit www.linemaster.com and click on Line Drawings located under the Guides & Literature Tab

⚠ WARNING SEE PRODUCT WARNING ON PAGE 103						
SPECIFICATIONS (Special variations are available to the O.E.M. on special order on the models listed below)						
AGENCY APPROVALS	EN 60529 Degree of Protection	CATALOG NUMBER	DESCRIPTION	CIRCUIT	FORM	ELECTRICAL RATINGS
	IP20	77SN9P ¹	Momentary	SPST-N.O. Grounded	A	500 MA 120 VAC 100 VDC 10 Watts Max.

¹6 ft. 18/3 SVT without plug.

NEMA TYPE 1, 2, 4, 6, 6P & 13
UL Enclosure 1, 2, 4, 6, 6P & 13
EN 60529 Degree of Protection IP68
Meets IEC 60601-2-2

Dust tight • Watertight • Oil tight • Corrosion Resistant
MILITARY GRADE DESIGN



Materials of Construction:

- Rugged aluminum casting is painted gray
- Piston type actuator sealed with O-rings
- 1/2"-14 N.P.T. threaded conduit entry.

Features & Benefits:

- Electrical contacts are sealed in a "well"
- Corrosion resistant housing & components
- 3 mounting holes provided for rigid mounting to floor or equipment

Options:

- Non-skid basepads available
- Custom colors - Special Order

Size (HxWxD):	2.22 x 4.28 x 7.00 In.
Weight:	2.73 lbs.
<i>For Dimension Drawings visit www.linemaster.com and click on Line Drawings located under the Guides & Literature Tab</i>	

⚠ WARNING SEE PRODUCT WARNING ON PAGE 103							
SPECIFICATIONS (Special variations are available to the O.E.M. on special order on the models listed below)							
AGENCY APPROVALS	EN 60529 Degree of Protection	CATALOG NUMBER	DESCRIPTION	NATIONAL STOCK NUMBER	CIRCUIT	FORM	ELECTRICAL RATINGS
	IP68	WP-541-SC	Momentary	5930-00-833-7090	SPDT	C	20 A 125-250 VAC 1 H.P. 125-250 VAC 10 A 28 VDC 1/2 A 125 VDC 1/4 A 250 VDC
	IP68	WP-541-DC	Maintained	5930-00-421-3217	SPDT	C	15 A 125 VAC 10 A 250 VAC

EN 60529 Degree of Protection IP20 (IP68 Upon Request)

Splash Resistant • Corrosion Resistant (Available)
MEDIUM DUTY GENERAL PURPOSE DESIGN

Materials of Construction:

- Constructed of Cast Iron for long life
- Non-skid base pad
- Adjustable Strain relief connector
- Durable black finish
- Model 632-DA can be used to control lighting
- Model 638-S features a cast aluminum housing painted Alert Orange with a splash resistant interior switch



Features & Benefits:

- Proven Reliability
- All maintained models offer “Push On-Push Off” action that insures long trouble-free performance
- 2 holes provided for rigid mounting to floor or equipment

Options:

- The wide treadle models offer a large seven inch target for the operator’s foot (See “Clipper - Twin & Wide Treadle” on page 46 for details)
- Available protective vinyl cover that can be applied over our Clipper. This boot is available only in bright orange, and provides additional protection to the foot switch from limited amounts of liquid, dust, dirt, mud and snow (See “Accessories - Protective Boot” on page 95 for details)
- AirVal models available (See “Clipper - Pneumatic AirVal” on page 68 for details)
- Heavy gauge steel guard available (See “Accessories - Guards” on pages 94 & 95 for details)

Size (HxWxD):	1.78 x 3.45 x 4.56 In.	<i>For Dimension Drawings visit www.linemaster.com and click on Line Drawings located under the Guides & Literature Tab</i>
Weight:	2.25 lbs.	

⚠️ WARNING SEE PRODUCT WARNING ON PAGE 103						
SPECIFICATIONS (Special variations are available to the O.E.M. on special order on the models listed below)						
AGENCY APPROVALS	EN 60529 Degree of Protection	CATALOG NUMBER	DESCRIPTION	CIRCUIT	FORM	ELECTRICAL RATINGS
UL, CE, CEE	IP20	632-S	Momentary	SPDT	C	20 A 125-250 VAC 1 H.P. 125-250 VAC
UL, CE	IP20	632-SC3 ¹	Momentary	SPST Wired N.O.	A	15 A 125 VAC 3/4 H.P. 125 VAC
UL, CE, CEE	IP20	632-SC36 ⁴	Momentary	SPST Wired N.O.	A	10 A 125-250 VAC 1/2 H.P. 125-250 VAC
UL, CE	IP20	632-DC3A ¹	Maintained	SPDT Wired N.O.	C	15 A 125 VAC 3/4 H.P. 125 VAC
UL, CE	IP20	633-S	Momentary	SPDT DB ³	Z	20 A 125-250 VAC 3/4 H.P. 125 VAC 1 H.P. 250 VAC
UL, CE, CEE	IP20	635-S	Momentary	DPDT	C	15 A 125 VAC 10 A 250 VAC
UL, CE, CEE	IP20	636-S	Two Stage Momentary	Each Stage SPDT	C	1/2 H.P. 125-250 VAC
UL, CE, CEE	IP20	632-DA	Maintained	SPDT	C	20 A 125 VAC 10 A 250 VAC 1 1/2 H.P. 120-240 VAC
UL, CE, CEE	IP20	634-DA	Maintained	DPDT	C	10 A 125-250 VAC 1/8 H.P. 125 VAC 1/4 H.P. 250 VAC
UL, CE, CEE	IP21	638-S	Momentary	SPDT	C	10 A 125-250 VAC 1/2 H.P. 125-250 VAC
UL, CE, CEE	IP21	638-SC38 ²	Momentary	SPDT Wired N.O.	A	

¹Supplied with 8 ft. 14/3 cord and 3 prong series plug. Green lead grounded. ²Supplied with 8 ft. 16/3 cord, wired N.O. with green lead grounded.
³DB Double Break models must be wired to equal voltage sources and the same polarity. The loads should be on the same sides of the line. ⁴Supplied with 6 ft. 18/3 cord.

Clipper - Twin & Wide Treadle



EN 60529 Degree of Protection IP20 (IP68 Upon Request)

Splash Resistant (Available)

MEDIUM DUTY GENERAL PURPOSE DESIGN

Materials of Construction:

- Constructed of Cast Iron for long life
- Non-skid base pad
- Adjustable Strain relief connector
- Durable black finish
- Model 642-DA can be used to control lighting

Features & Benefits:

- Proven Reliability
- All maintained models offer “Push On-Push Off” action that insures long trouble-free performance
- Wide Treadle Models have 2 holes provided for rigid mounting to floor or equipment
- Twin Models have 4 holes provided for rigid mounting to floor or equipment
- Divider Bar on Twin Models aids in Reducing Accidental Operation of Multiple Pedals at Once

Options:

- The wide treadle models offer a large seven inch target for the operator’s foot
- Aluminum housing available for Twin Models
- AirVal models available (See “Clipper Twin & Wide Treadle - Pneumatic AirVal” on page 69 for details)
- Heavy gauge steel guard available (See “Accessories - Guards” on pages 94 & 95 for details)



Twin	
Size (HxWxD):	1.87 x 8.38 x 4.54 In.
Weight:	5.00 lbs.
Wide Treadle	
Size (HxWxD):	1.78 x 7.00 x 5.50 In.
Weight:	3.63 lbs.
For Dimension Drawings visit www.linemaster.com and click on Line Drawings located under the Guides & Literature Tab	

⚠ WARNING SEE PRODUCT WARNING ON PAGE 103						
SPECIFICATIONS (Special variations are available to the O.E.M. on special order on the models listed below)						
AGENCY APPROVALS	EN 60529 Degree of Protection	CATALOG NUMBER	DESCRIPTION	CIRCUIT	FORM	ELECTRICAL RATINGS
UL, S, CE	IP20	TWIN 632-S	Twin / Momentary	Each Side SPDT	C	20 A 125-250 VAC 1 H.P. 125-250 VAC
e, UL, US, CE	IP20	TWIN 635-S	Twin / Momentary	Each Side DPDT	C	15 A 125 VAC 10 A 250 VAC 1/2 H.P. 125-250 VAC
S, UL, S, CE	IP20	642-S	Wide Treadle / Momentary	SPDT	C	20 A 125-250 VAC 1 H.P. 125-250 VAC
e, UL, US, CE	IP20	643-S	Wide Treadle / Momentary	SPDT DB ¹	Z	20 A 125-250 VAC 3/4 H.P. 125 VAC 1 H.P. 250 VAC
e, UL, US, CE	IP20	645-S	Wide Treadle / Momentary	DPDT	C	15 A 125 VAC 10 A 250 VAC
e, UL, US, CE	IP20	646-S	Wide Treadle / Momentary 2-Stage	Each Stage SPDT	C	1 1/2 H.P. 120-240 VAC
S, UL, S, CE	IP20	642-DA	Wide Treadle / Maintained	SPDT	C	20 A 125 VAC 10 A 250 VAC 1 1/2 H.P. 120-240 VAC

¹DB Double Break models must be wired to equal voltage sources and the same polarity. The loads should be on the same sides of the line.

EN 60529 Degree of Protection IP65 (IP68 Upon Request)

**Splash Resistant • Corrosion Resistant (Available)
MEDIUM DUTY GENERAL PURPOSE DESIGN**

Materials of Construction:

- Constructed of zinc die cast
- Non-skid base pad
- Durable black finish
- Integral adjustable strain relief clamp
- Operating Temperature Range: -20 degrees C to +80 degrees C (-4 degrees F to +176 degrees F)
- 1/2" - 14 NPT Conduit Entry

Features & Benefits:

- Proven Reliability
- 2 holes provided (2.875" center - to - center) for rigid mounting to floor or equipment
- Gasket seal provides superior protection from liquids
- Stainless steel exterior hardware
- Steel actuating mechanism
- Passivated stainless steel springs

Options:

- Heavy gauge steel guard available on special order
- Cabled variations available



Single	
Size (HxWxD):	2.13 x 3.50 x 5.61 In.
Weight:	2.50 lbs.
Twin	
Size (HxWxD):	2.25 x 8.50 x 5.61
Weight:	4.63 lbs.
<i>For Dimension Drawings visit www.linemaster.com and click on Line Drawings located under the Guides & Literature Tab</i>	

⚠ WARNING SEE PRODUCT WARNING ON PAGE 103 SPECIFICATIONS (Special variations are available to the O.E.M. on special order on the models listed below)						
AGENCY APPROVALS	EN 60529 Degree of Protection	CATALOG NUMBER	DESCRIPTION	CIRCUIT	FORM	ELECTRICAL RATINGS
UL US	IP65	911-SZ	Momentary	SPDT	C	20 A 125-250 VAC 1 H.P. 125-250 VAC
UL US	IP65	911-SC3Z ¹	Momentary	SPDT-N.O.	C	15A 125 VAC 1 H.P. 125 VAC
UL US	IP65	TWIN 911-SZ	Momentary	SPDT Each Side	C	20 A 125-250 VAC 1 H.P. 125-250 VAC

¹Supplied with 8 ft. 14/3 cord and 3 prong series plug. Green lead grounded.

EN 60529 Degree of Protection IP20 (IP68 Upon Request)

Splash Resistant (Available)

LOW PROFILE ERGONOMIC DESIGN

Materials of Construction:

- Constructed of cast aluminum cover and base
- Provided with a reversible strain relief clamp that accommodates a wide range of cable sizes
- Painted black

Features & Benefits:

- The low, sleek styling of this model reduces operator fatigue
- Nonskid base pads

Options:

- 24" wide version available on special order
- AirVal Models available on special orders



Size (HxWxD):	1.47 x 3.25 x 5.53 In.
Weight:	1.00 lbs.

For Dimension Drawings visit www.linemaster.com and click on Line Drawings located under the Guides & Literature Tab

⚠ WARNING SEE PRODUCT WARNING ON PAGE 103
 SPECIFICATIONS (Special variations are available to the O.E.M. on special order on the models listed below)

AGENCY APPROVALS	EN 60529 Degree of Protection	CATALOG NUMBER	DESCRIPTION	CIRCUIT	FORM	ELECTRICAL RATINGS
	IP20	121-S	Momentary	SPDT	C	20 A 125-250 VAC 1 H.P. 125-250 VAC
	IP20	124-S	Momentary	DPDT	C	15 A 125-250 VAC 1/2 H.P. 125-250 VAC

EN 60529 Degree of Protection IP20 (IP68 Upon Request)

Waterproof (Available)

LARGE LOW PROFILE ERGONOMIC DESIGN

Materials of Construction:

- Constructed of Cast Aluminum
- Painted gray

Features & Benefits:

- The parabolic curvature of the cover makes the Deluxe easy to operate without fatigue
- Full nonskid base pad

Options:

- Twin and triple models available - special order
- Guarding available contact Linemaster for details



Size (HxWxD):	1.71 x 4.91 x 5.44 In.
Weight:	1.00 lbs.

For Dimension Drawings visit www.linemaster.com and click on Line Drawings located under the Guides & Literature Tab

⚠ WARNING SEE PRODUCT WARNING ON PAGE 103						
SPECIFICATIONS (Special variations are available to the O.E.M. on special order on the models listed below)						
AGENCY APPROVALS	EN 60529 Degree of Protection	CATALOG NUMBER	DESCRIPTION	CIRCUIT	FORM	ELECTRICAL RATINGS
	IP20	81-S	Momentary	SPDT	C	10 A 125-250 VAC
	IP20	85-S	Two Stage Momentary	Each Stage SPDT	C	1/2 H.P. 125-250 VAC

EN 60529 Degree of Protection IP20 (IP68 Upon Request)

LARGE LOW PROFILE MULTI-FUNCTION DESIGN

Materials of Construction:

- Cover is molded from medium gray high impact polymeric material
- Base and treadles are made of a die cast zinc
- The cover tapers close to the floor in the front with a full five inches between the side treadle bars
- A Non-skid base pad provides a secure placement
- This multi-pedal foot switch should be considered when function, good looks and economy are required
- It incorporates a unique building block approach that allows the use of up to four basic SPDT snap switches
- SPECIAL VARIATIONS are available to the O.E.M. Special modifications include custom cordsets, nameplates, two stage operation, non operative cover, special circuits and a special translucent molded vinyl cover for added environmental protection against limited amounts of water and dirt
- Switch cover actuates separate function

Features & Benefits:

- Treadles are made of a die cast metal
- The cover tapers close to the floor in the front with a full five inches between the side treadle bars
- A Non-skid base pad provides a secure placement
- Supplied with internal adjustable Strain Relief for cord

Options:

- SPECIAL VARIATIONS are available to the O.E.M. Special modifications include custom cordsets, nameplates, two stage operation, non operative cover, special circuits and a special translucent molded vinyl cover for added environmental protection against limited amounts of water and dirt
- Available protective vinyl cover that can be applied over our Deluxe II. This cover is available only in Semi-clear, and provides additional protection to the foot switch from limited amounts of liquid, dust, dirt, mud and snow



Size (HxWxD):	1.67 x 6.87 x 5.64 In.
Weight:	2.00 lbs.

For Dimension Drawings visit www.linemaster.com and click on Line Drawings located under the Guides & Literature Tab

NOTE:

The translucent vinyl cover is made by a dip molding process. Minor cosmetic imperfections and blemishes are inherent in dip molded parts and must be expected. However, the basic environmental protection afforded is not affected.

▲ WARNING SEE PRODUCT WARNING ON PAGE 103							
SPECIFICATIONS (Special variations are available to the O.E.M. on special order on the models listed below)							
AGENCY APPROVALS	EN 60529 Degree of Protection	CATALOG NUMBER	DESCRIPTION	PEDALS	CIRCUIT	FORM	ELECTRICAL RATINGS
	IP20	68-S3	Dual Treadle / Momentary	2 Pedals plus Cover	SPDT	C	10 A 125-250 VAC 1/2 H.P. 125-250 VAC
	IP20	68-S3N	Dual Treadle / Momentary	2 Pedals ¹	SPDT	C	
	IP20	68-S4N	Dual Treadle / Momentary	2 Pedals ¹	DPDT	C	
	IP20	68-S2	Single Treadle / Momentary	1 Pedal plus Cover	SPDT	C	

¹Cover non-operative with side treadle bars active.



PATENTED

Aquiline® Momentary - Polymeric

EN 60529 Degree of Protection IP20 (IP68 Upon Request)

971-SWNO210 & 971-SWNO210A are NEMA Type 1, 4X, 6 & 6P – UL Enclosure 1, 4X, 6 & 6P, and IP68

**Watertight • Corrosion Resistant (Available)
VERSATILE COMPACT DESIGN**

Materials of Construction:

- SPDT, DPDT, Two-Stage, Momentary Operation
- Rustproof and corrosion proof polymeric material
- Raised ribs on treadle for positive traction during operation
- Integrated adjustable strain relief clamp accommodates cord sizes from .250 Dia. to .400 Dia.

Features & Benefits:

- Flame retardant to 94-VI
- Maximum versatility, total performance
- Non-skid base pad
- 2 holes provided for rigid mounting to Floor or equipment

Options:

- Custom colors, and color matching available with quantity orders
- Private Labeling
- Accessory base units available for configurations using multiple switches
- Stainless steel full guard (single) 522-K26 available (See “Accessories - Guards” on page 95 for details)
- Supplied with Series Plug (See “Stock Cordsets with Molded Plug” on page 96 for details) unless otherwise noted
- Special variations built to functional customers’ specifications are available on special order. Custom paint finishes, cordsets, nameplates and multi-pedal versions are available. Please contact LINEMASTER® for additional information
- Heavy gauge steel guard available (See “Accessories - Guards” on pages 94 & 95 for details)



Polymeric - Single		<i>For Dimension Drawings visit www.linemaster.com and click on Line Drawings located under the Guides & Literature Tab</i>
Size (HxWxD):	1.09 x 3.44 x 4.00 In.	
Weight:	3.60 oz.	

⚠ WARNING SEE PRODUCT WARNING ON PAGE 103

SPECIFICATIONS (Special variations are available to the O.E.M. on special order on the models listed below)

AGENCY APPROVALS	EN 60529 Degree of Protection	CATALOG NUMBER	DESCRIPTION	COLOR	CIRCUIT	FORM	ELECTRICAL RATINGS
	IP20	971-S	Polymeric / Momentary	Dark Gray	SPDT	C	15 A 125-250 VAC 1/2 H.P. 125-250 VAC
	IP20	971-SA	Polymeric / Momentary	Light Gray	SPDT	C	
	IP20	971-SB	Polymeric / Momentary	Blue	SPDT	C	
	IP20	971-SO	Polymeric / Momentary	Orange	SPDT	C	
	IP20	971-SY	Polymeric / Momentary	Yellow	SPDT	C	
	IP20	974-S	Polymeric / Momentary	Dark Gray	DPDT	C	15 A 125-250 VAC 1/2 H.P. 125-250 VAC
	IP20	974-SA	Polymeric / Momentary	Light Gray	DPDT	C	
	IP68	971-SWNO210 ¹	Polymeric / Momentary	Dark Gray	SPST Wired N.O.	A	3 A 25 VAC
	IP68	971-SWNO210A ¹	Polymeric / Momentary	Light Gray	SPST Wired N.O.	A	
	IP20	971-SC26 ²	Polymeric / Momentary	Dark Gray	SPDT Wired N.O.	A	10 A 125-250 VAC 1/2 H.P. 125-250 VAC
	IP20	971-SC26A ²	Polymeric / Momentary	Light Gray	SPDT Wired N.O.	A	

¹Meets IP68 & is supplied with 10 ft. 18/2 cord without plug.
²Supplied with 6 ft. 18/2 cord without plug.

EN 60529 Degree of Protection IP20 (IP68 Upon Request)

Corrosion Resistant VERSATILE COMPACT DESIGN

Materials of Construction:

- SPST, Maintained Operation
- Rustproof and corrosion proof reinforced polymeric material
- Raised ribs on treadle for positive traction during operation
- Integrated adjustable strain relief clamp accommodates cord sizes from .250 Dia. to .400 Dia.

Features & Benefits:

- Flame retardant to 94-VI
- Maximum versatility, total performance
- Non-skid base pad
- 2 holes provided for rigid mounting to Floor or equipment

Options:

- Custom colors, and color matching available with quantity orders
- Private Labeling
- Accessory base units available for configurations using multiple switches
- Stainless steel full guard (single) 522-K26 available (See "Accessories - Guards" on page 95 for details)
- Supplied with Series Plug (See "Stock Cordsets with Molded Plug" on page 96 for details) unless otherwise noted
- Special variations built to functional customers' specifications are available on special order. Custom paint finishes, cordsets, nameplates and multi-pedal versions are available. Please contact LINEMASTER® for additional information
- Heavy gauge steel guard available (See "Accessories - Guards" on pages 94 & 95 for details)



Polymeric - Single	
Size (HxWxD):	1.09 x 3.44 x 4.00 In.
Weight:	3.60 oz.
For Dimension Drawings visit www.linemaster.com and click on Line Drawings located under the Guides & Literature Tab	

▲ WARNING SEE PRODUCT WARNING ON PAGE 8 SPECIFICATIONS (Special variations are available to the O.E.M. on special order on the models listed below)							
AGENCY APPROVALS	EN 60529 Degree of Protection	CATALOG NUMBER	DESCRIPTION	COLOR	CIRCUIT	FORM	ELECTRICAL RATINGS
	IP20	971-DJ	Polymeric / Maintained	Dark Gray	SPST-NO	A	12 A 1 H.P. 250 VAC 1/2 H.P. 125 VAC
	IP20	971-DC3J ¹	Polymeric / Maintained	Dark Gray	SPST-NO	A	
	IP20	971-DC26J ²	Polymeric / Maintained	Dark Gray	SPST-NO	A	
	IP20	971-DC28J ³	Polymeric / Maintained	Dark Gray	SPST-NO	A	

¹Supplied with 8 ft. 16/3 cord with 3 prong series plug (Restricts use of foot switch assembly to 125 VAC Only). Plastic model is not grounded.
²Supplied with 6 ft. 16/2 cord, no ground.
³Supplied with 8 ft. 16/2 cord, no ground.

EN 60529 Degree of Protection IP20

VERSATILE COMPACT DESIGN

Materials of Construction:

- SPDT, DPDT, Two-Stage, Momentary or Maintained Operation
- Rustproof and corrosion proof cast zinc cover and formed steel base
- Raised ribs on treadle for positive traction during operation
- Integrated adjustable strain relief clamp accommodates cord sizes from .250 Dia. to .400 Dia.

Features & Benefits:

- Maximum versatility, total performance
- Non-skid base pad
- 2 holes provided for rigid mounting to Floor or equipment
- Twin model has Electrical Interlock feature

Options:

- Custom colors, and color matching available with quantity orders
- Private Labeling
- Accessory base units available for configurations using multiple switches
- Stainless steel full guard (single) 522-K26 available (See "Accessories - Guards" on page 95 for details)
- Supplied with Series Plug (See "Stock Cordsets with Molded Plug" on page 96 for details) unless otherwise noted
- Special variations built to functional customers' specifications are available on special order. Custom paint finishes, cordsets, nameplates and multi-pedal versions are available. Please contact us for additional information
- Heavy gauge steel guard available (See "Accessories - Guards" on pages 94 & 95 for details)
- For Medical multi switch options see page 13 for details



Single	
Size (HxWxD):	1.09 x 3.44 x 4.00 In.
Weight:	1.00 lb.
Twin	
Size (HxWxD):	1.25 x 7.547 x 5.562
Weight:	4.45 lbs.

For Dimension Drawings visit www.linemaster.com and click on Line Drawings located under the Guides & Literature Tab

WARNING SEE PRODUCT WARNING ON PAGE 103							
SPECIFICATIONS (Special variations are available to the O.E.M. on special order on the models listed below)							
AGENCY APPROVALS	EN 60529 Degree of Protection	CATALOG NUMBER	DESCRIPTION	COLOR	CIRCUIT	FORM	ELECTRICAL RATINGS
	IP20	971-DJM	Die Cast Zinc / Maintained	Black	SPST-NO	A	12 A 1 H.P. 250 VAC 1/2 H.P. 125 VAC
	IP20	971-DC3JM ¹	Die Cast Zinc / Maintained	Black	SPST-NO	A	
	IP20	971-DC36JM ²	Die Cast Zinc / Maintained	Black	SPST-NO	A	
	IP20	971-DC38JM ³	Die Cast Zinc / Maintained	Black	SPST-NO	A	
	IP20	971-SM	Die Cast Zinc / Momentary	Black	SPDT	C	15 A 125-250 VAC 1/2 H.P. 125-250 VAC
	IP20	972-S	Die Cast Zinc / Momentary 2-Stage	Black	SPDT Each Stage	C	
	IP20	974-SM	Die Cast Zinc / Momentary	Black	DPDT	C	
	IP20	TWIN 971-SMC48 ⁴	Die Cast Zinc / Momentary	Black	SPDT Wired N.O.	A	13 A 125-250 VAC 1/2 H.P. 125-250 VAC

¹Supplied with 8 ft. 16/3 cord with 3 prong series plug (Restricts use of foot switch assembly to 125 VAC Only). Plastic model is not grounded.

²Supplied with 6 ft. 16/3 cord, grounded. ³Supplied with 8 ft. 16/3 cord, grounded. ⁴Supplied with 8' 16/4 cord without plug. Green lead grounded.

EN 60529 Degree of Protection IP20

Splash Resistant (Available Momentary Only)
VERSATILE COMPACT DESIGN

Materials of Construction:

- Steel housing is painted Black
- Metal Mounting Plate spot welded to base on 491-SC36MP
- Twin Baseplate formed from cast aluminum
- The two pedal model is supplied with a divider bar between pedals which helps prevent accidental operation of both pedals at one time

Features & Benefits:

- Momentary & Maintained Models Non-Skid base pad for secure placement
- Compact in size and light in weight
- Supplied with internal adjustable strain relief
- Built for long life
- 2 Mounting Holes for Rigid Mounting to Floor or Equipment

Options:

- Rectangular mounting bracket is available for Compact models on special order. Bracket comes spot-welded to switch base and has two clearance holes for mounting
- Heavy gauge steel guard available (See "Accessories - Guards" on pages 94 & 95 for details)
- Airval models available (See "Compact Pneumatic Airval" on page 70 for details)



Single	
Size (HxWxD):	1.28 x 2.50 x 2.87 In.
Weight:	7.00 oz.
Twin	
Size (HxWxD):	1.46 x 5.98 x 2.875 In.
Weight:	1.25 lbs.
Mounting Bracket Model	
Size (HxWxD):	1.28 In. x 3.50 x 2.87 In.
Weight:	1.05 lbs.

For Dimension Drawings visit www.linemaster.com and click on Line Drawings located under the Guides & Literature Tab

⚠ WARNING SEE PRODUCT WARNING ON PAGE 103

SPECIFICATIONS (Special variations are available to the O.E.M. on special order on the models listed below)

AGENCY APPROVALS	EN 60529 Degree of Protection	CATALOG NUMBER	DESCRIPTION	CIRCUIT	FORM	ELECTRICAL RATINGS
	IP20	491-S	Single / Momentary	SPDT	C	10 A 125-250 VAC 1/2 H.P. 125-250 VAC
	IP20	491-SC36 ²	Single / Momentary	SPDT Wired N.O.	A	10 A 125 VAC 1/2 H.P. 125 VAC
	IP20	491-SC3 ¹	Single / Momentary	SPDT Wired N.O.	A	20 A 125-250 VAC 1 H.P. 125-250 VAC
	IP20	TWIN 491-S	Twin / Momentary	SPDT - Each Side	C	10 A 125-250 VAC 1/2 H.P. 125-250 VAC
	IP20	491-SC36MP ²	Single / Momentary with Mounting Plate	SPDT Wired N.O.	A	

¹Supplied with 8 ft. 16/3 cord with 3 prong series plug. Green lead grounded. ²Supplied with 6 ft. 16/3 cord without plug. Green lead grounded.

EN 60529 Degree of Protection IP20

Splash Resistant (Available Momentary Only)
VERSATILE COMPACT DESIGN

Materials of Construction:

- Zinc die-cast cover and base
- Black Powder-Coat paint finish
- Plastic base and cover inserts for insulation
- 18 Gauge, 8 foot cable on select models

Features & Benefits:

- Non-Skid base pad for secure placement
- Larger foot print and heavier than the original Compact
- Supplied with internal adjustable strain relief
- Built for long life
- 2 Mounting Holes for Rigid Mounting to Floor or Equipment

Options:

- Rectangular mounting bracket is available for Compact models on special order. Easy to assemble.
- Heavy gauge steel guard available (See “Accessories - Guards” on pages 94 & 95 for details)
- 25 Amp option available
- Plastic Cover Available
- IP68 (Waterproof) option available.



Single	
Size (HxWxD):	1.42 x 2.76 x 3.15 In.
Weight:	11.00 oz
<p><i>For Dimension Drawings visit www.linemaster.com and click on Line Drawings located under the Guides & Literature Tab</i></p>	

⚠ WARNING SEE PRODUCT WARNING ON PAGE 103 SPECIFICATIONS (Special variations are available to the O.E.M. on special order on the models listed below)						
AGENCY APPROVALS	EN 60529 Degree of Protection	CATALOG NUMBER	DESCRIPTION	CIRCUIT	FORM	ELECTRICAL RATINGS
	IP20	811-SZ	Single / Momentary	SPDT	C	20 A 125/250 VAC 1 1/2 H.P. 125 VAC; 2 H.P. 250 VAC
	IP20	811-SC3Z ¹	Single / Momentary	SPDT Wired N.O.	A	10 A 1/2 H.P. 125 VAC
	IP20	811-SC36Z ²	Single / Momentary	SPDT Wired N.O.	A	10 A 1/2 H.P. 125/250 VAC

¹Supplied with 8 ft. 18/3 cord with 3 prong series plug. Green lead grounded. ²Supplied with 8 ft. 18/3 cord without plug. Green lead grounded.

EN 60529 Degree of Protection IP20 (IP68 Upon Request)

Splash Resistant (Available) LIGHT DUTY COMPACT DESIGN

Materials of Construction:

- Strong steel housing is painted black
- Two single models mounted on a steel base
- A divider bar between pedals which helps prevent accidental operation of both switches at one time
- All wiring between the two switches is concealed

Features & Benefits:

- Nonskid base pad
- Designed to give a long economical service life
- Only one cord is brought out the right side eliminating the need for wire junctions & reducing wiring costs

Options:

- Triple Models Available
- Heavy gauge steel guard available (See "Accessories - Guards" on pages 94 & 95 for details)
- Rectangular mounting bracket is available for Hi-Treadlite models on special order
- Bracket comes spot-welded to switch base and has two clearance holes for mounting



Single	
Size (HxWxD):	1.37 x 2.625 x 3.56 In.
Weight:	10 oz.
Twin	
Size (HxWxD):	1.50 x 5.44 x 3.56 In.
Weight:	1.50 lbs.
For Dimension Drawings visit www.linemaster.com and click on Line Drawings located under the Guides & Literature Tab	

⚠ WARNING SEE PRODUCT WARNING ON PAGE 8 SPECIFICATIONS (Special variations are available to the O.E.M. on special order on the models listed below)						
AGENCY APPROVALS	EN 60529 Degree of Protection	CATALOG NUMBER	DESCRIPTION	CIRCUIT	FORM	ELECTRICAL RATINGS
	IP20	HT-52-S	Momentary	SPDT	C	20 A 125-250 VAC 1 H.P. 125-250 VAC
	IP20	HT-52-SC36 ¹	Momentary	SPST Wired N.O.	A	10 A 125-250 VAC 1/2 H.P. 125 VAC 1 H.P. 250 VAC
	IP20	TWIN HT-52-S	Momentary	SPDT - Each Side	C	20 A 125-250 VAC 1 H.P. 125-250 VAC

¹Supplied with 6 ft. 16/3 cord without plug. Green lead grounded.

EN 60529 Degree of Protection IP20 (IP68 Upon Request)

Drip tight • Dust tight • Watertight (Available)
COMPACT VERSATILE LOW PROFILE DESIGN

Materials of Construction:

- Steel housing is painted black
- Two single models mounted on a twin base plate with or without wiring channel
- A divider bar between pedals which helps prevent accidental operation of both switches at one time

Features & Benefits:

- Nonskid base pad and foot treadle pad
- 2 Holes provided for rigid mounting to floor or equipment
- The low profile and light pressure required to operate reduces operator fatigue

Options:

- Special Twin, Triple & Quad baseplates with wiring channel available on special order
- Stainless Steel Model Available (See "Treadlite II - Stainless Steel" on page 58 for details)
- Mounting Plate Available
- Heavy gauge steel guard available (See "Accessories - Guards" on pages 94 & 95 for details)



WARNING THE T-91-PS and T-91-PSNC ARE LOW POWER DEVICES AND MUST BE USED ONLY IN THOSE APPLICATIONS WHERE SUITABLE DESIGN CONSTRAINTS AND SAFETY PRECAUTIONS ARE MET.

Single		Twin Without Wire Channel	
Size (HxWxD):	1.00 x 2.63 x 3.50 In.	Size (HxWxD):	1.48 x 6.12 x 3.56 In.
Weight:	7.00 oz.	Weight:	1.50 lbs.
Twin with Wire Channel		<i>For Dimension Sheet visit www.linemaster.com and click on Line Drawings located under the Guides & Literature Tab</i>	
Size (HxWxD):	1.38 In. x 7.94 x 5.56		
Weight:	4.00 lbs.		

WARNING SEE PRODUCT WARNING ON PAGE 103

SPECIFICATIONS (Special variations are available to the O.E.M. on special order on the models listed below)

AGENCY APPROVALS	EN 60529 Degree of Protection	CATALOG NUMBER	DESCRIPTION	CIRCUIT	FORM	ELECTRICAL RATINGS
	IP20	T-91-S	Single / Momentary	SPDT	C	15 A 125-250 VAC 1/2 H.P. 125-250 VAC
	IP20	TWIN T-91-S ⁹	Single / Momentary	SPDT Each Side	C	15 A 125-250 VAC 1/2 H.P. 125-250 VAC
	IP20	T-91-SC36 ¹	Single / Momentary	SPDT Wired N.O.	A	10 A 125-250 VAC 1/2 H.P. 125-250 VAC
	IP20	T-91-SCEA ⁷	Single / Momentary	SPDT Wired N.O.	A	15 A 125-250 VAC 1/2 H.P. 125-250 VAC
	IP20	T-91-SC36A ²	Single / Momentary	SPDT Wired N.O.	A	15 A 125-250 VAC 1/2 H.P. 125-250 VAC
	IP20	T-91-SC3 ⁴	Single / Momentary	SPDT Wired N.O.	A	10 A 125 VAC 1/2 H.P. 125 VAC
	IP20	T-91-SC3A ⁵	Single / Momentary	SPDT Wired N.O.	A	15 A 125 VAC 1/2 H.P. 125 VAC
	IP20	T-91-PS ⁶	Single / Momentary	SPDT Wired N.O.	A	3 A 30 VAC Max. Class 2 Circuits Only
	IP20	T-91-PSNC ⁶	Single / Momentary	SPDT Wired N.C.	B	3 A 30 VAC Max. Class 2 Circuits Only
	IP20	T-91-SCE ⁸	Single / Momentary	SPDT Wired N.O.	A	16 A 125-250 VAC 1/2 H.P. 125-250 VAC
	IP20	T-91-SE	Single / Momentary	SPDT	C	16 A 125-250 VAC 1/2 H.P. 125-250 VAC
	IP20	TWIN T-91-SC48 ³	Twin / Momentary	SPDT Wired N.O. Both Sides	A	13 A 125-250 VAC 1/2 H.P. 125-250 VAC

¹Supplied with 6 ft. 18/3 cord without plug. Green lead grounded. ²Supplied with 6 ft. 14/3 cord without plug. Green lead grounded. ³Two T-91-S models mounted on a common steel baseplate, with a wiring channel & supplied with 8 ft. 16/4 cord without plug. Green lead grounded. ⁴Supplied with 6 ft. 18/3 cord with 3 prong series plug. Green lead grounded. ⁵Supplied with 8 ft. 14/3 cord with 3 prong series plug. Green lead grounded. ⁶Supplied with 8 ft. 22/1 audio cable with 2 contact .250 diameter phone plug, not grounded. ⁷Supplied with 2 meter 18/3 cord with brown, blue & green/yellow leads. ⁸Supplied with 2 meter 14/3 cord ⁹Two T-91-S models mounted on common cast aluminum base, no wiring Channel

Treadlite II - Stainless Steel



EN 60529 Degree of Protection IP68
NEMA Type 1, 4X, 6, & 6P IP68
UL Enclosure 1, 4X, 6, & 6P

Drip tight • Dust tight • Watertight • Corrosion Resistant (Available)
COMPACT VERSATILE LOW PROFILE DESIGN

Materials of Construction:

- Stainless Steel housing with brushed finish

Features & Benefits:

- Nonskid base pad and foot treadle pad
- The low profile and light pressure required to operate reduces operator fatigue

Options:

- Stainless Steel Full Guard Available
 (See “Accessories - Guards” on page 95 for details)



Size (HxWxD):	.85 x 2.63 x 3.50 In.
Weight:	8.00 oz.

For Dimension Drawings visit www.linemaster.com and click on Line Drawings located under the Guides & Literature Tab

⚠ WARNING SEE PRODUCT WARNING ON PAGE 103

SPECIFICATIONS (Special variations are available to the O.E.M. on special order on the models listed below)

AGENCY APPROVALS	EN 60529 Degree of Protection	CATALOG NUMBER	DESCRIPTION	CIRCUIT	FORM	ELECTRICAL RATINGS
cUL US	IP68	T-91-SWANOS ¹	Momentary	SPST-N.O.	A	3 A 125-250 VAC
cUL US	IP68	T-91-SWANO3S ²	Momentary	SPST wired N.O.	A	3 A 125 VAC
cUL US	IP68	T-91-SWANO38S ³	Momentary	SPST wired N.O.	A	3 A 125-250 VAC

¹Supplied without cordset.
²Supplied with 8 ft. 18/3 cord and 3-prong series plug, green lead grounded.
³Supplied with 8 ft. 18/3 cord without plug, green lead grounded.

EN 60529 Degree of Protection IP20 (IP68 Upon Request)

Splash Resistant • Corrosion Resistant (Available)

LIGHT DUTY GENERAL PURPOSE DESIGN

Materials of Construction:

- Steel Housing is painted black
- Ribbed rubber foot pad for traction
- Steel fasteners
- Non-skid base pad for traction on various surfaces
- Internal plastic strain relief connector

Features & Benefits:

- Proven Reliability
- 2 holes provided for rigid mounting to floor or equipment
- The low profile and light pressure required to operate reduces operator fatigue.
- Front Hinge position for ease of actuation.

Options:

- Heavy gauge steel guard available
- Cabled variations available
- Multipedal options available on special order.



Size (HxWxD):	1.18 x 2.89 x 3.60 In.
Weight:	7 oz. / 1 lb. Corded

For Dimension Drawings visit www.linemaster.com and click on Line Drawings located under the Guides & Literature Tab

⚠ WARNING SEE PRODUCT WARNING ON PAGE 103

SPECIFICATIONS (Special variations are available to the O.E.M. on special order on the models listed below)

AGENCY APPROVALS	EN 60529 Degree of Protection	CATALOG NUMBER	DESCRIPTION	CIRCUIT	FORM	ELECTRICAL RATINGS
	IP20	T-91-SFZ	Single / Momentary	SPDT	C	15 A 125-250 VAC 1/2 H.P. 125-250 VAC
	IP20	T-91-SC3FZ ¹	Single / Momentary	SPDT Wired N.O.	A	10 A 125 VAC 1/2 H.P. 125 VAC
	IP20	T-91-SC36FZ ²	Single / Momentary	SPDT Wired N.O.	A	10 A 125 VAC 1/2 H.P. 125 VAC

¹ Supplied with 6 ft. 18/3 cord with 3 prong series plug. Green lead grounded.

² Supplied with 6 ft. 18/3 cord without plug. Green lead grounded.

NEMA Type 2, 4, 6 & 6P
EN 60529 Degree of Protection IP68
Meets IEC 60601-2-2

Drip tight • Dust tight • Watertight
HIGH IMPACT LOW PROFILE OMNI-DIRECTIONAL DESIGN

Materials of Construction:

- Actuation from any direction with moderate pressure
- The cover and base is molded in a high impact polymeric compound
- Base includes mounting provisions

Features & Benefits:

- Low profile to aide in elimination of fatigue
- A nonskid base pad
- Wired normally open, no ground

Options:

- Stainless Steel Weight Plate Available
- Custom Cable Available



⚠ WARNING INTENDED FOR INDOOR USE PRIMARILY TO PROVIDE A DEGREE OF PROTECTION AGAINST THE ENTRY OF WATER DURING OCCASIONAL TEMPORARY SUBMERSION AT A LIMITED DEPTH.

Size (DIA. X H):	3.50 x 1.00 In.
Weight:	9.00 oz.

For Dimension Drawings visit www.linemaster.com and click on Line Drawings located under the Guides & Literature Tab

⚠ WARNING SEE PRODUCT WARNING ON PAGE 103						
SPECIFICATIONS (Special variations are available to the O.E.M. on special order on the models listed below)						
AGENCY APPROVALS	EN 60529 Degree of Protection	CATALOG NUMBER	DESCRIPTION	CIRCUIT	FORM	ELECTRICAL RATINGS
cULus	IP68	D41-SNO28 ¹	Momentary	SPST Wired N.O.	A	5 A Resistive 125 VAC 28 VDC 3 A General Purpose 125 VAC
¹ Supplied with 8 ft. 18/2 cord without plug.						

EN 60529 Degree of Protection IP20 (IP68 Upon Request)

Splash Resistant (Available)

LARGE LOW PROFILE OMNI-DIRECTIONAL DESIGN

Materials of Construction:

- Round Nickel Chrome Cover
- Heavy Gauge Steel Base plate
- Stain resistant black nitrile Nonskid Base Pad
- The cable shroud provides additional flex protection for the cable

Features & Benefits:

- Designed for long life use
- Operates From Any Direction with moderate pressure
- Extended cable Flex Protection
- Cable shroud provides additional flex protection for cable
- The internal reversible cable clamp accepts a wide range of cable sizes

Options:

- Custom paint finish available on cover
- AirVal models available (See "Premier - Pneumatic AirVal" on page 66 for details)
- Linear models available contact Linemaster for details



Size (Dia. x H):	5.75 x 1.50 In.
Weight:	2.00 lbs.
<i>For Dimension Drawings visit www.linemaster.com and click on Line Drawings located under the Guides & Literature Tab</i>	

⚠ WARNING SEE PRODUCT WARNING ON PAGE 103						
SPECIFICATIONS (Special variations are available to the O.E.M. on special order on the models listed below)						
AGENCY APPROVALS	EN 60529 Degree of Protection	CATALOG NUMBER	DESCRIPTION	CIRCUIT	FORM	ELECTRICAL RATINGS
	IP20	P32-S	Momentary	SPDT	C	20 A 125-250 VAC 1 H.P. 125-250 VAC
	IP20	P31-SC3 ¹	Momentary	SPDT Wired N.O.	A	10 A 125-250 VAC 1/2 H.P. 125-250 VAC
	IP20	P31-SC36 ²	Momentary	SPDT Wired N.O.	A	

¹Supplied with 6 ft. 18/3 cord with 3 prong series plug. Green lead grounded. ²Supplied with 6 ft. 18/3 cord without plug. Green lead grounded.

NEMA Type 2 UL ENCLOSURE 2 (VK ONLY)
EN 60529 Degree of Protection IP21 (IP68 Upon Request)

Drip tight • Dust tight (VK ONLY) Corrosion Resistant
COMPACT OMNI-DIRECTIONAL DESIGN

Materials of Construction:

- Mounted in a chrome plated heavy zinc die cast housing
- A full nonskid base pad
- A special vinyl cover gives added environmental protection against limited amounts of water and dirt
- The dip molded cover is bonded to the vinyl base pad of the foot switch

Features & Benefits:

- Features a round black actuating cap
- Moderate pressure from any direction operates the switch
- Standard models supplied with cordset
- Wired normally open and grounded
- Ease of operation with foot or hand
- The cable entry boot is clinched tight to the cordset

Options:

- Special paint finish available
- Silk Screening available
- Special single wiring channel with or without side protectors available
- Twin version available
- Linear models available contact Linemaster for details
- European type foot switch is offered pre wired with 3 conductor cordset having brown, blue and green/yellow colored leads. It is a momentary contact and wired normally open with green/yellow lead grounded to switch base



V Series	
Size (Dia. x H):	3.81 x 1.30 In.
Weight:	1.00 lbs.
VK Series	
Size (Dia. x H):	5.06 x 1.57 In.
Weight:	1.50 lbs.

For Dimension Drawings visit www.linemaster.com and click on Line Drawings located under the Guides & Literature Tab

⚠ WARNING SEE PRODUCT WARNING ON PAGE 103						
SPECIFICATIONS (Special variations are available to the O.E.M. on special order on the models listed below)						
AGENCY APPROVALS	EN 60529 Degree of Protection	CATALOG NUMBER	DESCRIPTION	CIRCUIT	FORM	ELECTRICAL RATINGS
cUL _{US}	IP21	GEM-VK3 ¹	Momentary / Vinyl Cover	SPST Wired N.O.	A	10 A 125 VAC 1/2 H.P. 125 VAC
cUL _{US} CE	IP21	GEM-VK36 ²	Momentary / Vinyl Cover	SPST Wired N.O.	A	10 A 125-250 VAC 1/2 H.P. 125-250 VAC
cUL _{US} CE	IP20	GEM-VCEA ³	Momentary	SPST Wired N.O.	A	10 A 125-250 VAC 1/2 H.P. 125-250 VAC
cUL _{US} CE	IP20	GEM-V2	Momentary	SPDT	C	15 A 125-250 VAC 1/2 H.P. 125-250 VAC
cUL _{US}	IP20	GEM-V3 ¹	Momentary	SPST Wired N.O.	A	10 A 125 VAC 1/2 H.P. 125 VAC
cUL _{US} CE	IP20	GEM-V36 ²	Momentary	SPST Wired N.O.	A	10 A 125-250 VAC 1/2 H.P. 125-250 VAC

¹Supplied with 6 ft. 18/3 cord and 3 prong series plug. Green lead grounded. ²Supplied with 6 ft. 18/3 cord without plug. Green lead grounded.
³Supplied with 2 meter 18/3 brown, blue & green/yellow leads.

EN 60529 Degree of Protection IP20 (IP68 Upon Request)

Motion Control Device ROCKER ACTION LOW PROFILE DESIGN

Materials of Construction:

- Cover is a medium gray Die Cast Zinc material
- Mechanical Interlock—prevents both circuits from being operated at the same time
- Operates on the teeter-totter principle
Pressure on one side opens or closes line, release of pressure returns switch to normal off position, pressure on other side opens or closes circuit, independent of first

Features & Benefits:

- Non-skid Base pad
- Both sides can be wired normally open or normally closed
- All wiring connections are made internally with only a single cord being brought out
- Eliminates costly harness assemblies
- Offers real economy

Options:

- Twin, Triple, Quad & Quint versions available
- Heavy gauge steel guard available (See “Accessories - Guards” on pages 94 & 95 for details)
- Twin and Triple version guards available contact Linemaster for details



Size (HxWxD):	1.62 x 4.28 x 4.75 In.
Weight:	1.50 lbs.

For Dimension Drawings visit www.linemaster.com and click on Line Drawings located under the Guides & Literature Tab

⚠ WARNING SEE PRODUCT WARNING ON PAGE 103						
SPECIFICATIONS (Special variations are available to the O.E.M. on special order on the models listed below)						
AGENCY APPROVALS	EN 60529 Degree of Protection	CATALOG NUMBER	DESCRIPTION	CIRCUIT	FORM	ELECTRICAL RATINGS
c	IP20	72	Momentary	SPDT Each Side	C	10 A 125-250 VAC
c	IP20	74	Momentary	DPDT Each Side	C	1/2 H.P. 125-250 VAC

EN 60529 Degree of Protection IP20

Motion Control Device

ROCKER ACTION COMPACT DESIGN

Materials of Construction:

- Steel Housing
- Black finish
- Mechanical Interlock—prevents both circuits from being operated at the same time
- Operates on the teeter-totter principle
Pressure on one side opens or closes line, release of pressure returns switch to normal off position, pressure on other side opens or closes circuit, independent of first

Features & Benefits:

- Non-skid Base pad
- Both sides can be wired normally open or normally closed
- All wiring connections are made internally with only a single cord being brought out
- Eliminates costly harness assemblies
- Offers real economy

Options:

- Twin version available
- Multiple cable entry locations available
- Mounting provisions can be added
- Custom labeling
- Splash resistant interior switch available



Size (HxWxD):	1.21 x 2.75 x 5.00 In.
Weight:	10 oz.

For Dimension Drawings visit www.linemaster.com and click on Line Drawings located under the Guides & Literature Tab

⚠ WARNING SEE PRODUCT WARNING ON PAGE 103						
SPECIFICATIONS (Special variations are available to the O.E.M. on special order on the models listed below)						
AGENCY APPROVALS	EN 60529 Degree of Protection	CATALOG NUMBER	DESCRIPTION	CIRCUIT	FORM	ELECTRICAL RATINGS
	IP20	L-2-S	Momentary	SPDT Each Side	C	10 A 125-250 VAC 1/2 H.P. 125-250 VAC



EN 60529 Degree of Protection IP20
UL available on Special Orders

Motion Control Device
HEAL-TO-TOE ROCKER ACTION DESIGN

Materials of Construction:

- Die cast Aluminum housing
- Black finish
- Mechanical Interlock—prevents both circuits from being operated at the same time
- Operates on the teeter-totter principle
 Pressure on one side opens or closes line, release of pressure returns switch to normal off position, pressure on other side opens or closes circuit, independent of first



Features & Benefits:

- Non-skid Base pad
- Housing is pivoted in the center for easy heal-toe operation
- Both sides can be wired normally open or normally closed
- All wiring connections are made internally with only a single cord being brought out
- Adjustable strain relief connector that accommodates a wide range of cable sizes
- Eliminates costly harness assemblies
- Offers real economy

Options:

- DPDT Available on Special Orders
- Available with UL approval

Size (HxWxD):	2.09 x 3.50 x 8.31 In.
Weight:	1.75 lbs.

For Dimension Drawings visit www.linemaster.com and click on Line Drawings located under the Guides & Literature Tab

⚠ WARNING SEE PRODUCT WARNING ON PAGE 103						
SPECIFICATIONS (Special variations are available to the O.E.M. on special order on the models listed below)						
AGENCY APPROVALS	EN 60529 Degree of Protection	CATALOG NUMBER	DESCRIPTION	CIRCUIT	FORM	ELECTRICAL RATINGS
N/A	IP20	476-S	Momentary	SPDT Each Side	C	15 A 125-250 VAC 1/2 H.P. 125-250 VAC

Variable Pneumatic Control

LARGE LOW PROFILE OMNI-DIRECTIONAL DESIGN

Materials of Construction:

- Internal Valve is constructed of a Non-Ferrous body, Stainless steel plunger and Teflon coated buna-N O-rings
- Air flows when plunger is depressed, stops flowing when plunger is released and exhausts back pressure on output side
- Air exhausts around plunger
- Plunger can be depressed flush with valve body without damage to valve
- Standard 1/8-27 N.P.T. input and output ports
- Filtered and lubricated air supply is required for best operation
- Line pressure up to 150 P.S.I.
- Round nickel chrome cover

Features & Benefits:

- Designed for long life operation
- Two-Way models do not exhaust back pressure
- Stain resistant black nitrile Non-skid Base Pad
- Operates from any direction
- Extended tubing flex protection
- Cable shroud provides additional flex protection for tubing

Options:

- Special paint finish available



⚠ WARNING COMPRESSED AIR IS POWERFUL – ALWAYS USE CARE. MAXIMUM LINE PRESSURE UP TO 150 P.S.I.

Size (DIA x H):	5.70 x 1.50 In.
Weight:	1.81 lbs.

For Dimension Drawings visit www.linemaster.com and click on Line Drawings located under the Guides & Literature Tab

⚠ WARNING SEE PRODUCT WARNING ON PAGE 103						
SPECIFICATIONS (Special variations are available to the O.E.M. on special order on the models listed below)						
AGENCY APPROVALS	CATALOG NUMBER	DESCRIPTION	AIR FLOW AT 100 P.S.I.	EXHAUST AT 100 P.S.I.	OPERATING FORCE	PORTS 1/8-27 N.P.T.
N/A	2P-30A2-S	2-Way Momentary	30 C.F.M.	25 C.F.M.	8 to 22 Pounds	Inside Housing
N/A	3P-30A2-S	3-Way Momentary	30 C.F.M.	25 C.F.M.	8 to 22 Pounds	Inside Housing

Maintained/Momentary Pneumatic Control

LARGE INDUSTRIAL DESIGN

Materials of Construction:

- Internal Valve is constructed of a Non-Ferrous body, Stainless steel plunger and Teflon coated buna-N O-rings
- Air flows when plunger is depressed, stops flowing when plunger is released and exhausts back pressure on output side
- Air exhausts around plunger
- Plunger can be depressed flush with valve body without damage to valve
- Standard 1/8-27 N.P.T. input and output ports
- Filtered and lubricated air supply is required for best operation
- Line pressure up to 150 P.S.I.
- Robust cast iron housing

Features & Benefits:

- Designed for long life operation
- Full shield or OX shield covering treadle
- 3 Holes provided for rigid mounting to floor or equipment

Options:

- Hercules AirVal also available as a 3-way in either single or 2-stage versions on special order
- 2 Stage models available
- Momentary and maintained versions available



4-Way Model

⚠ WARNING COMPRESSED AIR IS POWERFUL – ALWAYS USE CARE. MAXIMUM LINE PRESSURE UP TO 150 P.S.I.

Size (HxWxD):	4.37 x 5.87 x 9.00 In.
Weight:	7.51 lbs.

For Dimension Drawings visit www.linemaster.com and click on Line Drawings located under the Guides & Literature Tab

⚠ WARNING SEE PRODUCT WARNING ON PAGE 103						
SPECIFICATIONS (Special variations are available to the O.E.M. on special order on the models listed below)						
AGENCY APPROVALS	CATALOG NUMBER	DESCRIPTION	AIR FLOW AT 100 P.S.I.	EXHAUST AT 100 P.S.I.	OPERATING FORCE	PORTS 1/8-27 N.P.T.
N/A	3H-25H2-S4H	3-Way Momentary, 2 Stage	30 C.F.M.	25 C.F.M.	19 Pounds	Exterior Housing
N/A	3H-25H2-S4HOX	3-Way Momentary, 2 Stage	30 C.F.M.	25 C.F.M.	19 Pounds	Exterior Housing
N/A	3H-25H2-D4H	3-Way Maintained, 2 Stage	30 C.F.M.	25 C.F.M.	19 Pounds	Exterior Housing
N/A	4H-30H2-SHOX	4-Way Momentary	30 C.F.M.	25 C.F.M.	19 Pounds	Exterior Housing
N/A	4H-30H2-DHOX	4-Way Maintained	30 C.F.M.	25 C.F.M.	19 Pounds	Exterior Housing

Variable/Momentary Pneumatic Control

MEDIUM DUTY GENERAL PURPOSE DESIGN

Materials of Construction:

- Internal Valve is constructed of a Non-Ferrous body, Stainless steel plunger and Teflon coated buna-N O-rings
- Air flows when plunger is depressed, stops flowing when plunger is released and exhausts back pressure on output side
- Air exhausts around plunger
- Operating temperature 0° to 131° F (-18° to +55°C)
- Rugged Cast Iron Housing

Features & Benefits:

- Designed for long life operation
- Nonskid Base Pad
- Two-Way models do not exhaust back pressure
- Plunger can be depressed flush with valve body without damage to valve
- Standard 1/8-27 N.P.T. input and output ports
- Filtered and lubricated air supply is required for best operation
- Line pressure up to 150 P.S.I.
- 2 holes provided for rigid mounting to floor or equipment

Options:

- 2-way, 3-way and 4-way models available
- Heavy gauge steel guard available (See "Accessories - Guards" on pages 94 & 95 for details)



⚠ WARNING COMPRESSED AIR IS POWERFUL – ALWAYS USE CARE. MAXIMUM LINE PRESSURE UP TO 150 P.S.I.

2-Way and 3-Way	
Size (HxWxD):	1.78 x 3.45 x 4.56 In.
Weight:	2.50 lbs.
4-Way	
Size (HxWxD):	1.78 x 3.45 x 4.56 In.
Weight:	2.50 lbs.

For Dimension Drawings visit www.linemaster.com and click on Line Drawings located under the Guides & Literature Tab

⚠ WARNING SEE PRODUCT WARNING ON PAGE 103						
SPECIFICATIONS (Special variations are available to the O.E.M. on special order on the models listed below)						
AGENCY APPROVALS	CATALOG NUMBER	DESCRIPTION	AIR FLOW AT 100 P.S.I.	EXHAUST AT 100 P.S.I.	OPERATING FORCE	PORTS 1/8-27 N.P.T.
N/A	2C-30A2-S	2-Way Momentary	30 C.F.M.	25 C.F.M.	10 Pounds	Interior Housing
N/A	3C-30A2-S	3-Way Momentary	30 C.F.M.	25 C.F.M.	10 Pounds	Interior Housing
N/A	4C-30F2-S	4-Way Momentary	30 C.F.M.	25 C.F.M.	19 Pounds	Exterior Housing



Clipper Twin & Wide Treadle - Pneumatic AirVal

Variable/Momentary Pneumatic Control

MEDIUM DUTY GENERAL PURPOSE DESIGN

Materials of Construction:

- Internal Valve is constructed of a Non-Ferrous body, Stainless steel plunger and Teflon coated buna-N O-rings
- Air flows when plunger is depressed, stops flowing when plunger is released and exhausts back pressure on output side
- Air exhausts around plunger
- Operating temperature 0° to 131° F (-18° to +55° C)
- Rugged Cast Iron Housing

Features & Benefits:

- Designed for long life operation
- Nonskid Base Pad
- Plunger can be depressed flush with valve body without damage to valve
- Standard 1/8-27 N.P.T. input and output ports
- Filtered and lubricated air supply is required for best operation
- Line pressure up to 150 P.S.I.

Options:

- Variable available on Special Order
- Heavy gauge steel guard available (See "Accessories - Guards" on pages 94 & 95 for details)



COMPRESSED AIR IS POWERFUL – ALWAYS USE CARE. MAXIMUM LINE PRESSURE UP TO 150 P.S.I.

Twin	
Size (HxWxD):	1.87 x 8.38 x 4.54 In.
Weight:	5.00 lbs.
Wide Treadle	
Size (HxWxD):	1.87 x 7.00 x 5.50 In.
Weight:	3.75 lbs.

For Dimension Drawings visit www.linemaster.com and click on Line Drawings located under the Guides & Literature Tab

WARNING SEE PRODUCT WARNING ON PAGE 103						
SPECIFICATIONS (Special variations are available to the O.E.M. on special order on the models listed below)						
AGENCY APPROVALS	CATALOG NUMBER	DESCRIPTION	AIR FLOW AT 100 P.S.I.	EXHAUST AT 100 P.S.I.	OPERATING FORCE	PORTS 1/8-27 N.P.T.
N/A	TWIN 3C-30A2-S	3-Way Momentary Each Pedal	30 C.F.M.	25 C.F.M.	10 Pounds	Interior Housing
N/A	3L-30A2-S	Wide Treadle 3-Way Momentary	30 C.F.M.	25 C.F.M.	8 Pounds	Interior Housing

Momentary Pneumatic Control

VERSATILE COMPACT DESIGN

Materials of Construction:

- Internal Valve is constructed of a Non-Ferrous body, Stainless steel plunger and Teflon coated buna-N O-rings
- Air flows when plunger is depressed, stops flowing when plunger is released and exhausts back pressure on output side
- Air exhausts around plunger
- Strong Steel Housing

Features & Benefits:

- Nonskid Base Pad
- Designed for long life operation
- Two-Way models do not exhaust back pressure
- Plunger can be depressed flush with valve body without damage to valve
- Standard 1/8-27 N.P.T. input and output ports
- Filtered and lubricated air supply is required for best operation
- Line pressure up to 150 P.S.I.

Options:

- Twin Version Available
- Heavy gauge steel guard available (See "Accessories - Guards" on pages 94 & 95 for details)



WARNING COMPRESSED AIR IS POWERFUL – ALWAYS USE CARE. MAXIMUM LINE PRESSURE UP TO 150 P.S.I.

Single	
Size (HxWxD):	1.28 x 2.50 x 2.88 In.
Weight:	.50 lbs.
Twin	
Size (HxWxD):	1.47 x 5.75 x 2.88 In.
Weight:	1.50 lbs.
<i>For Dimension Drawings visit www.linemaster.com and click on Line Drawings located under the Guides & Literature Tab</i>	

WARNING SEE PRODUCT WARNING ON PAGE 103						
SPECIFICATIONS (Special variations are available to the O.E.M. on special order on the models listed below)						
AGENCY APPROVALS	CATALOG NUMBER	DESCRIPTION	AIR FLOW AT 100 P.S.I.	EXHAUST AT 100 P.S.I.	OPERATING FORCE	PORTS 1/8-27 N.P.T.
N/A	2B-30A2-S	Single 2-Way Momentary	30 C.F.M.	25 C.F.M.	7 Pounds	Exterior Housing
N/A	3B-30A2-S	Single 3-Way Momentary	30 C.F.M.	25 C.F.M.	7 Pounds	Exterior Housing
N/A	TWIN 3B-30A2-S	3-Way Momentary Each Side	30 C.F.M.	25 C.F.M.	7 Pounds	Exterior Housing

Variable/Momentary Pneumatic Control

LONG TREADLE THROW DESIGN

Materials of Construction:

- Variable Flow design
- Internal Valve is constructed of a Non-Ferrous body, Stainless steel plunger and Teflon coated buna-N O-rings
- Air flows when plunger is depressed, stops flowing when plunger is released and exhausts back pressure on output side
- Air exhausts around plunger
- Versatility and Good Looks
- Cast Aluminum Housing

Features & Benefits:

- Nonskid Base Pad
- Designed for long life operation
- Two-Way models do not exhaust back pressure
- Plunger can be depressed flush with valve body without damage to valve
- Standard 1/8-27 N.P.T. input and output ports
- Filtered and lubricated air supply is required for best operation
- Line pressure up to 150 P.S.I.

Options:

- 2-way, 3-way & Variable
- Heavy gauge steel guard available (See "Accessories - Guards" on pages 94 & 95 for details)



⚠ WARNING COMPRESSED AIR IS POWERFUL – ALWAYS USE CARE. MAXIMUM LINE PRESSURE UP TO 150 P.S.I.

Size (HxWxD):	1.68 x 3.25 x 5.39 In.
Weight:	1.00 lb.
<i>For Dimension Drawings visit www.linemaster.com and click on Line Drawings located under the Guides & Literature Tab</i>	

⚠ WARNING SEE PRODUCT WARNING ON PAGE 103						
SPECIFICATIONS (Special variations are available to the O.E.M. on special order on the models listed below)						
AGENCY APPROVALS	CATALOG NUMBER	DESCRIPTION	AIR FLOW AT 100 P.S.I.	EXHAUST AT 100 P.S.I.	OPERATING FORCE	PORTS 1/8-27 N.P.T.
N/A	2E-30A2-S	2-Way Momentary	30 C.F.M.	NONE	2 ¹ / ₂ Pounds	Interior Housing
N/A	3E-30A2-S	3-Way Momentary	30 C.F.M.	25 C.F.M.	2 ¹ / ₂ Pounds	Interior Housing
N/A	2E-20V2-S	2-Way Variable Momentary	20 C.F.M.	NONE	2 ¹ / ₂ Pounds	Interior Housing
N/A	3E-20V2-S	3-Way Variable Momentary	20 C.F.M.	6 C.F.M.	2 ¹ / ₂ Pounds	Interior Housing

EN 60529 Degree of Protection IPXX Master Actuator
EN 60529 Degree of Protection IP00 Snap Switch

Momentary/Maintained Air Switch • Isolated Electric Snap Switch
COMPACT VERSATILE DESIGN



Materials of Construction:

- Strong Steel Housing
- Long Life Air bulb actuator mounted in Housing
- Remotely located air operated Electric Snap Switch
- Supplied with a 10 foot 1/8" ID PVC tubing connecting the foot pedal to the remote air switch
- The tubing is connected at the foot switch end using a molded on strain relief grommet providing superior pull out protection

Features & Benefits:

- Remote switch equipped with a 9/16" U.N.F. bulkhead mount
- Available in either momentary or maintained SPDT versions
- Provides versatility in applications
- Isolating the electrically live snap switch from the floor
- Offers environmental protection from short or shock
- 2 holes provided for rigid Mounting to floor or equipment

Options:

- Momentary or Maintained models available
- Mounting Plate Available
- Black tubing available
- Twin model available on special order
- Heavy gauge steel guard available (See "Accessories - Guards" on pages 94 & 95 for details)

Size (HxWxD):	1.28 x 2.74 x 2.88 In.
Weight:	.91 lbs.

For Dimension Drawings visit www.linemaster.com and click on Line Drawings located under the Guides & Literature Tab

⚠ WARNING SEE PRODUCT WARNING ON PAGE 103							
SPECIFICATIONS (Special variations are available to the O.E.M. on special order on the models listed below)							
AGENCY APPROVALS	EN 60529 Degree of Protection	CATALOG NUMBER	DESCRIPTION	CIRCUIT	FORM	OPERATING TEMPERATURE RANGE	ELECTRICAL RATINGS
c	IPXX	41SH12 ¹	Momentary	SPDT	C	10°F to 120°F ²	20 A 125-250 VAC 1 H.P. 125 VAC 2 H.P. 250 VAC
		41DH12 ¹	Maintained				

¹ Supplied with 10 ft. 1/8" I.D. reinforced Clear PVC tubing. ² The operating temperature range will vary with different lengths of tubing. Please consult the factory for details.

**EN 60529 Degree of Protection IPXX Master Actuator
EN 60529 Degree of Protection IP00 Snap Switch**

**Momentary/Maintained Air Switch • Isolated Electric Snap Switch
ERGONOMIC VERSATILE DESIGN**

Materials of Construction:

- Molded PVC bulb
- Designed with isolated electrical air switch
- Combines a foot operated air bulb and a remotely located electric snap switch
- Brass fittings
- Actuating Bulb supplied with two grommet mounting holes (*Standard Only*)

Features & Benefits:

- Easy to operate by hand or foot
- Up to 30 foot range using PVC tubing
- Isolates operation from electrically live switch
- Offers environmental protection from short or shock
- Designed for long life trouble free operation
- Simple field replacement of components
- Application versatility
- Ease of interfacing

Options:

- Air foot switches are also available in the Premier and Dolphin housings, as well as, a hand operated version
- Aluminum Baseplate
- DPDT Model available
- Clear reinforced tubing available



Actuating Bulb	
Size (HxWxD):	1.26 x 4.59 x 2.77 In.
Weight:	.20 lbs.
Actuating Hand Bulb	
Size (HxWxD):	1.20 x 2.12 x 1.75 In.
Weight:	.15 lbs.
Snap Switch	
Size (HxWxD):	1.00 x .78 x .50 In.
Weight:	.15 lbs.

For Dimension Drawings visit www.linemaster.com and click on Line Drawings located under the Guides & Literature Tab

⚠ WARNING SEE PRODUCT WARNING ON PAGE 103							
SPECIFICATIONS (Special variations are available to the O.E.M. on special order on the models listed below)							
AGENCY APPROVALS	EN 60529 Degree of Protection	CATALOG NUMBER	DESCRIPTION	CIRCUIT	FORM	OPERATING TEMPERATURE RANGE	ELECTRICAL RATINGS
cUL US CE	N/A	81SH12 ¹	Standard Momentary	SPDT	C	10°F to 120°F ²	20 A 125-250 VAC 1 H.P. 125 VAC 2 H.P. 250 VAC
		81DH12 ¹	Standard Maintained				
cUL US CE	N/A	PBSH12 ¹	Hand Bulb Momentary	SPDT	C	10°F to 120°F ²	20 A 125-250 VAC 1 H.P. 125 VAC 2 H.P. 250 VAC

¹ Supplied with 8 ft. 1/8" I.D. Black PVC tubing. ² The operating temperature range will vary with different lengths of tubing. Please consult the factory for details.

EN 60529 Degree of Protection IPXX Master Actuator
EN 60529 Degree of Protection IP00 Snap Switch

Momentary/Maintained Air Switch • Isolated Electric Snap Switch
ERGONOMIC VERSATILE DESIGN



Materials of Construction:

- Molded PVC bulb
- Designed with isolated electrical air switch
- Combines a foot operated air bulb and a remotely located electric snap switch
- Stainless Steel fitting
- Actuating Bulb supplied with Internal Weight Plate

Features & Benefits:

- Easy to operate
- Up to 30 foot range using PVC tubing
- Isolates operation from electrically live switch
- Offers environmental protection from short or shock
- Designed for long life trouble free operation
- Simple field replacement of components
- Application versatility
- Ease of interfacing
- Molded in weight plate for greater stability
- Smooth black shiny finish

Options:

- DPDT Model available

Actuating Bulb	
Size (DIA x H):	5.00 x 1.36 In.
Weight:	.80 lbs.
Snap Switch	
Size (HxWxD):	1.00 x .78 x .50 In.
Weight:	.15 lbs.
<i>For Dimension Drawings visit www.linemaster.com and click on Line Drawings located under the Guides & Literature Tab</i>	

⚠ WARNING SEE PRODUCT WARNING ON PAGE 103 SPECIFICATIONS (Special variations are available to the O.E.M. on special order on the models listed below)							
AGENCY APPROVALS	EN 60529 Degree of Protection	CATALOG NUMBER	DESCRIPTION	CIRCUIT	FORM	OPERATING TEMPERATURE RANGE	ELECTRICAL RATINGS
	IPXX	12SH12 ¹	Momentary	SPDT	C	20°F to 120°F ²	20 A 125-250 VAC
		12DH12 ¹	Maintained				1 H.P. 125 VAC
							2 H.P. 250 VAC

¹ Supplied with 10 ft. 1/8" I.D. black PVC tubing. ² The operating temperature range will vary with different lengths of tubing. Please consult the factory for details.

EN 60529 Degree of Protection IP20

Rustproof • Corrosion Resistant SPEED CONTROL DEVICE

Materials of Construction:

- Steel baseplate for increased strength
- Supplied with dual cordsets, single series plug or custom modified for the O.E.M.
- Polymeric material will not rust or corrode

Features & Benefits:

- Variable control of small fractional horsepower Universal motors, leaving hands free
- Full Wave variable speed mode, provides higher torque at low RPM's and smoother control of the motor.
- Standard color is black; custom colors may be quoted on large O.E.M. orders
- 2 holes provided for rigid mounting to floor or equipment
- Hall Effect Sensor technology that provides consistent and accurate performance over the life of the foot control, while offering a longer life for the foot control.
- Electronic calibration ensures accurate motor control over the full travel of the pedal.
- Overcurrent Protected.

Options:

- Steel Weight plate available
- Heavy gauge steel guard available (See "Accessories - Guards" on pages 94 & 95 for details)



Size (HxWxD):	2.25 x 4.00 x 6.34 In.
Weight:	1.21 lbs.

For Dimension Drawings visit www.linemaster.com and click on Line Drawings located under the Guides & Literature Tab

⚠ WARNING SEE PRODUCT WARNING ON PAGE 103

SPECIFICATIONS (Special variations are available to the O.E.M. on special order on the models listed below)

AGENCY APPROVALS	EN 60529 Degree of Protection	CATALOG NUMBER	DESCRIPTION	CORDSET(S)	ELECTRICAL RATINGS
	IP20	982-SC3	Momentary	6' 18/3 SVT with 3-prong plug 1' 18/3 SVT with mating receptacle	6 A 115 VAC
	IP20	982-SC36	Momentary	6' 18/3 SVT with outer jacket stripped back 1' 18/3 SVT with outer jacket stripped back	6 A 115 VAC 3 A 230 VAC

Hercules - Potentiometer - No Shield



NEMA Type 1, 2, 4 & 13
EN 60529 Degree of Protection IP56 (IP68 Upon Request)

Drip tight • Dust tight • Watertight • Oil tight
NO SHIELD

Materials of Construction:

- Treadle, cover and housing constructed from cast iron for strength and durability
- Painted Alert Orange
- Single 3/4"-14 N.P.T. threaded conduit entry is standard
- This switch is designed for use with variable speed motor drives and is available in selected 2 watt linear values
- Depressing the treadle rotates the potentiometer from zero to the selected maximum resistance shown below
- The treadle is spring loaded and returns to the normal position when the foot pressure is removed
- Auxiliary switch contact rated at 15 Amps
125-250 VAC can be added to the control
- The switch will operate at the beginning of the treadle stroke
- Up to 3 SPDT switches can be added and adjusted for operation at any point of the treadle stroke



Features & Benefits:

- Rugged cast metal enclosure has sufficient weight to keep the switch from sliding when being operated
- All models have a neoprene cover gasket plus O-rings on the activating shaft and a separate ground screw
- 3 holes provided for rigid mounting to the floor or equipment
- Specify the maximum resistance you want

Options:

- Special Dual 1/2"-14 N.P.T. threaded conduit entry and metric sizes available to the O.E.M. on special order
- Hercules foot operated potentiometers are available with 5,000 Ohm or 10,000 Ohm values. Other potentiometer values are available upon request or by special order. Please contact the office for availability and pricing
- Hercules models available with cast aluminum base and covers (except unshielded cover which is gray iron)

Size (HxWxD):	3.16 x 4.06 x 8.38 In.
Weight:	7.00 lbs.

For Dimension Drawings visit www.linemaster.com and click on Line Drawings located under the Guides & Literature Tab

⚠ WARNING SEE PRODUCT WARNING ON PAGE 103						
SPECIFICATIONS (Special variations are available to the O.E.M. on special order on the models listed below)						
Replace xx in Catalog Number with value of Potentiometer in Ohms. (i.e. 500-N-5K)						
AGENCY APPROVALS	EN 60529 Degree of Protection	CATALOG NUMBER	DESCRIPTION	CIRCUIT	FORM	ELECTRICAL RATINGS
	IP56	500-N-xx	Momentary	No Auxiliary Contact	-	15 A 125-250 VAC
	IP56	500-AN-xx	Momentary	1 Auxiliary SPDT Contact	C	
	IP56	500-A2N-xx	Momentary	2 Auxiliary Snap Switches	C	
	IP56	500-A3N-xx	Momentary	3 Auxiliary Snap Switches	C	

NEMA Type 1, 2, 4 & 13
EN 60529 Degree of Protection IP56 (IP68 Upon Request)

Drip tight • Dust tight • Watertight • Oil tight
STANDARD FULL SHIELD



Materials of Construction:

- Treadle and housing constructed from cast iron for strength and durability
- Protected by a strong cast aluminum Shield
- Painted Alert Orange
- Single 3/4"-14 N.P.T. threaded conduit entry is standard
- This switch is designed for use with variable speed motor drives and is available in selected 2 watt linear values
- Depressing the treadle rotates the potentiometer from zero to the selected maximum resistance shown below
- The treadle is spring loaded and returns to the normal position when the foot pressure is removed
- Auxiliary switch contact rated at 15 Amps 125-250 VAC can be added to the control
- The switch will operate at the beginning of the treadle stroke
- Up to 3 SPDT switches can be added and adjusted for operation at any point of the treadle stroke

Features & Benefits:

- Rugged cast metal enclosure has sufficient weight to keep the switch from sliding when being operated
- All models have a neoprene cover gasket plus O-rings on the activating shaft and a separate ground screw
- 3 holes provided for rigid mounting to the floor or equipment
- Specify the maximum resistance you want

Options:

- Special Dual 1/2"-14 N.P.T. threaded conduit entry and metric sizes available to the O.E.M. on special order
- Hercules foot operated potentiometers are available with 5,000 Ohm or 10,000 Ohm values. Other potentiometer values are available upon request or by special order. Please contact the office for availability and pricing
- Hercules models available with cast aluminum base and covers (except unshielded cover which is gray iron)

Size (HxWxD):	4.37 x 5.88 x 9.00 In.
Weight:	7.50 Ibs.

For Dimension Drawings visit www.linemaster.com and click on Line Drawings located under the Guides & Literature Tab

⚠ WARNING SEE PRODUCT WARNING ON PAGE 103						
SPECIFICATIONS (Special variations are available to the O.E.M. on special order on the models listed below)						
Replace xx in Catalog Number with value of Potentiometer in Ohms. (i.e. 500-H-5K)						
AGENCY APPROVALS	EN 60529 Degree of Protection	CATALOG NUMBER	DESCRIPTION	CIRCUIT	FORM	ELECTRICAL RATINGS
	IP56	500-H-xx	Momentary	No Auxiliary Contact	-	15 A 125-250 VAC
	IP56	500-AH-xx	Momentary	1 Auxiliary SPDT Contact	C	
	IP56	500-A2H-xx	Momentary	2 Auxiliary SPDT Contacts	C	
	IP56	500-A3H-xx	Momentary	3 Auxiliary SPDT Contacts	C	

Hercules - Potentiometer - O Shield



NEMA Type 1, 2, 4 & 13
EN 60529 Degree of Protection IP56 (IP68 Upon Request)

Drip tight • Dust tight • Watertight • Oil tight
OVERSIZED SHIELD



Materials of Construction:

- Treadle and housing constructed from cast iron for strength and durability
- Protected by a strong cast aluminum Shield
- Painted Alert Orange
- Single 3/4"-14 N.P.T. threaded conduit entry is standard
- This switch is designed for use with variable speed motor drives and is available in selected 2 watt linear values
- Depressing the treadle rotates the potentiometer from zero to the selected maximum resistance shown below
- The treadle is spring loaded and returns to the normal position when the foot pressure is removed
- Auxiliary switch contact rated at 15 Amps 125-250 VAC can be added to the control
- The switch will operate at the beginning of the treadle stroke
- Up to 3 SPDT switches can be added and adjusted for operation at any point of the treadle stroke

Features & Benefits:

- Rugged cast metal enclosure has sufficient weight to keep the switch from sliding when being operated
- All models have a neoprene cover gasket plus O-rings on the activating shaft and a separate ground screw
- 3 holes provided for rigid mounting to the floor or equipment
- Specify the maximum resistance you want

Options:

- Special Dual 1/2"-14 N.P.T. threaded conduit entry and metric sizes available to the O.E.M. on special order
- Hercules foot operated potentiometers are available with 5,000 Ohm or 10,000 Ohm values. Other potentiometer values are available upon request or by special order. Please contact the office for availability and pricing
- Hercules models available with cast aluminum base and covers (except unshielded cover which is gray iron)

Size (HxWxD):	5.03 x 5.88 x 9.13 In.
Weight:	8.00 lbs.

For Dimension Drawings visit www.linemaster.com and click on Line Drawings located under the Guides & Literature Tab

⚠ WARNING SEE PRODUCT WARNING ON PAGE 103						
SPECIFICATIONS (Special variations are available to the O.E.M. on special order on the models listed below)						
Replace xx in Catalog Number with value of Potentiometer in Ohms. (i.e. 500-HO-5K)						
AGENCY APPROVALS	EN 60529 Degree of Protection	CATALOG NUMBER	DESCRIPTION	CIRCUIT	FORM	ELECTRICAL RATINGS
	IP56	500-HO-xx	Momentary	No Auxiliary Contact	-	15 A 125-250 VAC
	IP56	500-AHO-xx	Momentary	1 Auxiliary SPDT Contact	C	
	IP56	500-A2HO-xx	Momentary	2 Auxiliary Snap Switches	C	
	IP56	500-A3HO-xx	Momentary	3 Auxiliary Snap Switches	C	

NEMA Type 1, 2, 4 & 13
EN 60529 Degree of Protection IP56 (IP68 Upon Request)

Drip tight • Dust tight • Watertight • Oil tight
EXTRA OVSIZED SHIELD

Materials of Construction:

- Treadle and housing constructed from cast iron for strength and durability
- Protected by a strong cast aluminum Shield
- Painted Alert Orange
- Single 3/4"-14 N.P.T. threaded conduit entry is standard
- This switch is designed for use with variable speed motor drives and is available in selected 2 watt linear values
- Depressing the treadle rotates the potentiometer from zero to the selected maximum resistance shown below
- The treadle is spring loaded and returns to the normal position when the foot pressure is removed
- Auxiliary switch contact rated at 15 Amps 125-250 VAC can be added to the control
- The switch will operate at the beginning of the treadle stroke
- Up to 3 SPDT switches can be added and adjusted for operation at any point of the treadle stroke



Features & Benefits:

- Rugged cast metal enclosure has sufficient weight to keep the switch from sliding when being operated
- All models have a neoprene cover gasket plus O-rings on the activating shaft and a separate ground screw
- 3 holes provided for rigid mounting to the floor or equipment
- Specify the maximum resistance you want

Options:

- Special Dual 1/2"-14 N.P.T. threaded conduit entry and metric sizes available to the O.E.M. on special order
- Hercules foot operated potentiometers are available with 5,000 Ohm or 10,000 Ohm values. Other potentiometer values are available upon request or by special order. Please contact the office for availability and pricing
- Hercules models available with cast aluminum base and covers (except unshielded cover which is gray iron)

Size (HxWxD):	5.78 x 6.03 x 9.13 In.
Weight:	8.25 lbs.

For Dimension Drawings visit www.linemaster.com and click on Line Drawings located under the Guides & Literature Tab

⚠ WARNING SEE PRODUCT WARNING ON PAGE 103						
SPECIFICATIONS (Special variations are available to the O.E.M. on special order on the models listed below)						
Replace xx in Catalog Number with value of Potentiometer in Ohms. (i.e. 500-HOX-5K)						
AGENCY APPROVALS	EN 60529 Degree of Protection	CATALOG NUMBER	DESCRIPTION	CIRCUIT	FORM	ELECTRICAL RATINGS
	IP56	500-HOX-xx	Momentary	No Auxiliary Contact	-	15 A 125-250 VAC
	IP56	500-AHOX-xx	Momentary	1 Auxiliary SPDT Contact	C	
	IP56	500-A2HOX-xx	Momentary	2 Auxiliary SPDT Contact	C	
	IP56	500-A3HOX-xx	Momentary	3 Auxiliary SPDT Contact	C	

EN 60529 Degree of Protection IP20

Variable Control Potentiometer

LONG TREADLE THROW LARGE FOOTPRINT DESIGN

Materials of Construction:

- Steel housing electro-coated black finish
- Complete with full treadle pad and nonskid base pad
- Spring return pedal action on momentary models
- Adjustable friction pad design on maintained models
- Maximum resistance must be specified when ordering

Features & Benefits:

- Retrofits most welding equipment with a simple receptacle selection
- For environments where a non-watertight housing is suitable
- 2 holes provided for rigid mounting to floor or equipment
- Heel rest offered on "OH" models

Options:

- Custom cable lengths available
- Varior foot operated potentiometers are available with 5,000 Ohm or 10,000 Ohm values. Other potentiometer values are available upon request or by special order. Please contact the office for availability and pricing.



ESAB • HOBART • LINCOLN • MILLER WELDING EQUIPMENT REPLACEMENT FOOT CONTROLS

Standard	
Size (HxWxD):	4.17 x 4.50 x 9.71 In.
Weight:	4.91 lbs.
Industrial	
Size (HxWxD):	4.00 x 4.52 x 12.78 In.
Weight:	5.00 lbs.
For Dimension Drawings visit www.linemaster.com and click on Line Drawings located under the Guides & Literature Tab	

NOTE:

Contact **LINEMASTER®** for replacement foot controls for your **ESAB®, Hobart®, Lincoln® or Miller®** welding equipment.

⚠ WARNING SEE PRODUCT WARNING ON PAGE 103				
SPECIFICATIONS (Special variations are available to the O.E.M. on special order on the models listed below)				
Replace xx in Catalog Number with value of Potentiometer in Ohms. (i.e. 09ASXP-5K)				
AGENCY APPROVALS	EN 60529 Degree of Protection	CATALOG NUMBER	DESCRIPTION	CORDSET
	IP20	09ASXP-xx	Momentary	Supplied with a 6 ft. 18/4 cordset without plug. Wired three leads to potentiometer and green lead to ground.
	IP20	09ARXU-xx	Maintained	
	IP20	09ASAC-xx	Momentary	Supplied with 6 ft. 18/6 cordset without plug, with auxiliary switch set to operate at the beginning of treadle stroke and wired N.O. Three leads to potentiometer and green lead to ground.
	IP20	09ARAC-xx	Maintained	
	IP20	OHASAC-xx	Momentary	
	IP20	OHASAA-1K	Momentary	Supplied with 25' 18/6 cordset with 14 pin plug compatible with Hobart® & Miller®
	IP20	OHASAA-5KW	Momentary	Supplied with 25' 18/6 cordset with 14 pin plug compatible with Hobart® & Miller® (NOTE: Waterproof Potentiometer)
	IP20	OHASAB-10K	Momentary	Supplied with 25' 18/6 cordset with 6 pin plug compatible with Lincoln®
	IP20	OHASAD-10K	Momentary	Supplied with 30' 18/6 cordset with 14 pin plug compatible with ESAB®

EN 60529 Degree of Protection

Electronic Throttle Control CUSTOM APPLICATION SPECIFIC DESIGN

Materials of Construction:

- Steel housing electro-coated black finish
- Weather Resistant Components
- Complete with full treadle pad and nonskid base pad
- Spring return pedal action on momentary models
- Adjustable friction pad design on maintained models
- Maximum resistance must be specified when ordering
- Custom Mounting Configurations
- Custom Arm Configurations
- Custom Linkage Configurations

Features & Benefits:

- Retrofit installations
- For environments where a non-watertight housing is suitable
- Rigid mounting to floor or equipment
- Heel rest offered

Options:

- Auxiliary Switch(es) Available
- Rotary Potentiometer Available
- Hall Effect Circuit output available
- Custom cable lengths available
- Varior foot operated potentiometers are available with 5,000 Ohm or 10,000 Ohm values. Other potentiometer values are available upon request or by special order. Please contact the office for availability and pricing



Introducing LINEMASTER® Throttle Controls. There are numerous applications for these controls, including use in various types of electric vehicles where accurate control of speed is required. LINEMASTER® offers a rugged construction for long life, ergonomic friendly designs and ease of operation. If you have an application that requires a throttle control, please contact our Customer Service Department for details.

Assemblies	
Size (HxWxD):	Application Specific
Weight:	Application Specific
Enclosures	
Size (HxWxD):	4.20 x 4.50 x 11.90 In.
Weight:	4.00 lbs
<i>For Dimension Drawings visit www.linemaster.com and click on Line Drawings located under the Guides & Literature Tab</i>	

⚠️ WARNING SEE PRODUCT WARNING ON PAGE 103

This device is of an application specific design. Please Contact LINEMASTER® for additional Information 1-860-974-1000

EN 60529 Degree of Protection IP68 and IP20

Drip tight • Dust tight • Watertight • Rust Proof • Corrosion Resistant
SMALL LIGHTWEIGHT LOW PROFILE DESIGN

Materials of Construction:

- Cover & Base formed from Light Gray (PMS 427C) ABS Polymeric Material
- Non-glare finish
- Silver Alloy contacts
- SPDT, DPDT, Two-Stage, Momentary Operation
- Integrated adjustable strain relief clamp accommodates cord sizes from .250" Dia. to .400" Dia

Features & Benefits:

- Maximum versatility, total performance in a small package
- Rustproof and corrosion Resistant
- Mounting holes provided for rigid mounting to floor and or equipment
- Non-Skid Feet
- Raised Dimples on treadle for positive traction during operation
- 10 A 125-250 VAC rating
- Designed to meet UL, CSA & CE requirements

Options:

- Custom colors and color matching available with quantity orders
- Fully submersible in water (IP68 Only)
- Twin & Triple models available
- Accessory base units available for configurations using multiple switches
- Heavy gauge steel guard available (See "Accessories - Guards" on pages 94 & 95 for details)
- Custom connectivity options including Universal Serial Bus (USB)
- Custom cabling available
- 3 A 125-250 VAC & 5 A 125-250 VAC ratings available



Size (HxWxD):	1.05 x 2.50 x 3.48 In.
Weight:	4 oz.

For Dimension Drawings visit www.linemaster.com and click on Line Drawings located under the Guides & Literature Tab

⚠ WARNING SEE PRODUCT WARNING ON PAGE 103						
This device is of an application specific design. Please Contact LINEMASTER® for additional Information: 1-860-974-1000						
AGENCY APPROVALS	EN 60529 Degree of Protection	CATALOG NUMBER	DESCRIPTION	CIRCUIT	FORM	ELECTRICAL RATINGS
	IP10	SL1-S	Single Pedal/Momentary	SPDT	C	10 A 125-250 VAC
	IP10	SL2-S	Single Pedal/Momentary	SPDT - 2 Stage	C	
	IP10	SL4-S	Single Pedal/Momentary	DPDT	C	
	IP68	SL1-SWBNO210 ¹	Single Pedal/Momentary	SPDT	C	5 A 125-250 VAC
	IP68	SL2-SWBNO410 ²	Single Pedal/Momentary	SPDT - 2 Stage	C	
	IP68	SL4-SWANO410 ²	Single Pedal/Momentary	DPDT	C	3 A 125 VAC 2 A 250 VAC
	IP68	SL4-SWBNO310 ³	Single Pedal/Momentary	DPDT	C	5 A 125-250 VAC
	IP68	SL4-SWBNO410 ²	Single Pedal/Momentary	DPDT	C	

¹ Supplied with 10 ft., 2 conductor, 18 awg cord ² Supplied with 10 ft., 4 conductor, 18 awg cord ³ Supplied with 10 ft., 3 conductor, 18 awg cord

**EN 60529 Degree of Protection IP68
FCC**

Drip tight • Dust tight • Watertight • Oil tight

Materials of Construction:

- Treadle and housing constructed from cast iron for strength and durability
- Protected by a strong cast aluminum oversized shield
- Painted Alert Orange

Features & Benefits:

- Removes clutter of wires under foot
- IP68 fully submersible in water Transmitter
- IPX1 Degree of Protection for the Receiver
- Rugged cast metal enclosure has sufficient weight to keep the switch from sliding when being operated
- All models have a neoprene cover gasket plus O-rings on the activating shaft and a separate ground screw
- Heavy duty weather resistant construction for harsh environments
- Momentary actuation Contacts: single pole, double throw, up to 10 amp service
- Available in up to 3 switch functions
- Multiple systems may be used in the same vicinity at the same time
- 40 foot range of RF Transmission
- 700 hours of battery life at 50% duty cycle
- 3 (AA) batteries required for Transmitter
- 3 holes provided for rigid mounting to the floor or equipment
- Available for US and European service
- 802.15.4 Compliant
- 2.405 - 2.480 GHz, 15 Channels Available

Options:

- Oversize “OX” Shield model accepts oversized safety shoes and metatarsal foot guards. The “OX” Shield has an additional 3/4” (19.1 mm) opening height as compared to the “O” shield
- Handle option available for ease of maneuvering the foot pedal
- Receiver powered by 6 Volt Adapter
- Twin Versions Available for special order



Oversized Cover Guard Model		Certification: UL Listed to UL 508 CUL investigated to C22.2 No. 14-05 FCC ID #VPA-SP-831
Size (HxWxD):	5.03 in. x 5.88 in. x 9.13 in.	
Weight:	8.00 lbs.	
Oversized Cover Guard with Handle Model		<i>For Dimension Drawings visit www.linemaster.com and click on Line Drawings located under the Guides & Literature Tab</i>
Size (HxWxD):	35.78 in. x 6.03 in. x 9.13 in.	
Weight:	9.00 lbs.	

⚠ WARNING SEE PRODUCT WARNING ON PAGE 103

SPECIFICATIONS (Special variations are available to the O.E.M. on special order on the models listed below)

AGENCY APPROVALS	EN 60529 Degree of Protection	CATALOG NUMBER	DESCRIPTION	STAGE	CIRCUIT	FORM	ELECTRICAL RATINGS
	IP68 Transmitter IPX1 Receiver	SP-831-111000XA	Momentary, OX-Shield	Single	SPDT	C	Max. Switched Voltage: 380 VAC Max. Switched Current: 14A N.O., AC resistive; 8 amps DC Max. Switched Power: 200W, DC; 2,000V A, AC Min. Required Contact Load: 12V, 100mA VDE Contact Ratings: 8 amps, 250 VAC UL Contact Ratings: 10 amps, 240 VAC; 8 amps 24 VDC 1/3 HP, 120 VAC; 1/2 HP, 240 VAC
		SP-831-111101XA		Single	DPDT	C	
		SP-831-111202XA		Single	TPDT	C	
		SP-831-111100XA	Momentary, OX-Shield with Handle	Single	SPDT	C	
		SP-831-111201XA		Single	DPDT	C	
		SP-831-111302XA		Single	TPDT	C	

Special Variations Available upon request.

NEMA Type

Classified to IEC/UL 60601.1

Classified to Can/CSA C22.2 No. 60601.1

EN 60529 Degree of Protection IP68 (Transmitter Only)

EN 60529 Degree of Protection IPX1 (Receiver Only)

Meets EMC Directive EN60601-1-2

Federal Communications Commission (FCC) Compliant

Drip tight • Dust tight • Watertight • Oil tight • Rust Proof • Corrosion Resistant
DIGITAL RF WIRELESS DEVICE



Materials of Construction:

- Switch Functions: Maximum combinations of 5
- Mode change switch available
- Transmitter battery life: 700 hours @ 50% duty cycle typical
- Power Consumption (Transmitter): Stand-by 2ua
- Standard Power Requirements (Receiver): 6VDC @ 200ma (other voltages optional)
- Transmitter low battery indicator
- Receiver output: SPST relay, 0.5 amp contacts; SPDT relays optional
- Receiver switch activation indicator(s)
- High impact plastic wiring channel and receiver housing

Features & Benefits:

- 2.405 - 2.480 GHz, Channels 1-15
- 802.15.4 Compliant
- Meets IEC 60601 3rd Edition
- Automatic RF power level adjustment of Transmitter
- Waterproof - IP68 degree of protection for foot pedal (Transmitter)
- IPX1 degree of protection for Receiver
- 50 foot range typical
- Typical Latency: < 65ms
- Uses industry standard AA Alkaline batteries
- Eliminates the need for cords
- Retrofits most existing equipment
- No product calibration required – plug and go
- Submersible transmitter for easy cleaning

Options:

- Protective bag available for easy clean-up

Transmitter (Switch)	
Size (HxWxD):	2.63 x 8.09 x 8.93 In.
Weight:	3.70 lbs. with batteries
Receiver	
Size (HxWxD):	2.25 x 5.00 x 3.50 In.
Weight:	.45 lbs.
For Dimension Drawings visit www.linemaster.com and click on Line Drawings located under the Guides & Literature Tab	

Classified to IEC/UL Medical Electrical Equipment by Underwriter's Laboratories, Inc. with respect to fire, shock, and mechanical hazards in accordance with IEC/UL 60601.1

Classified with respect to electric shock, fire, mechanical, and other specified hazards only, in accordance with Can/CSA C22.2 No. 60601.1

Meets EMC Directive EN60601-1-2

WARNING SEE PRODUCT WARNING ON PAGE 103

This device is of an application specific design. Please Contact LINEMASTER® for additional Information: 1-860-974-1000

NEMA Type

Classified to IEC/UL 60601.1

Classified to Can/CSA C22.2 No. 60601.1

EN 60529 Degree of Protection IP68 (Transmitter Only)

EN 60529 Degree of Protection IPX1 (Receiver Only)

Meets EMC Directive EN60601-1-2

Federal Communications Commission (FCC) Compliant



**Drip tight • Dust tight • Watertight • Oil tight •
Rust Proof • Corrosion Resistant
DIGITAL RF WIRELESS DEVICE**

Materials of Construction:

- Switch Functions: Maximum combinations of 5
- Mode change switch available
- Transmitter battery life: 700 hours @ 50% duty cycle typical
- Power Consumption (Transmitter): Stand-by 2ua
- Standard Power Requirements (Receiver): 6VDC @ 200ma (other voltages optional)
- Transmitter low battery indicator
- Receiver output: SPST relay, 0.5 amp contacts; SPDT relays optional
- Receiver switch activation indicator(s)
- High impact plastic wiring channel and receiver housing

Features & Benefits:

- 2.405 - 2.480 GHz, Channels 1-15
- 802.15.4 Compliant
- Meets IEC 60601 3rd Edition
- Automatic RF power level adjustment of Transmitter
- Waterproof - IP68 degree of protection for foot pedal (Transmitter)
- IPX1 degree of protection for Receiver
- 50 foot range typical
- Typical Latency: < 65ms
- Uses industry standard AA Alkaline batteries
- Eliminates the need for cords
- Retrofits most existing equipment
- No product calibration required – plug and go
- Submersible transmitter for easy cleaning

Options:

- Protective bag available for easy clean-up

Transmitter (Switch)	
Size (HxWxD):	2.63 x 14.00 x 9.41 In.
Weight:	5.50 lbs. with batteries
Receiver	
Size (HxWxD):	2.25 x 5.00 x 3.50 In.
Weight:	.45 lbs.
<i>For Dimension Drawings visit www.linemaster.com and click on Line Drawings located under the Guides & Literature Tab</i>	

Classified to IEC/UL Medical Electrical Equipment by Underwriter's Laboratories, Inc. with respect to fire, shock, and mechanical hazards in accordance with IEC/UL 60601.1

Classified with respect to electric shock, fire, mechanical, and other specified hazards only, in accordance with Can/CSA C22.2 No. 60601.1

Meets EMC Directive EN60601-1-2

WARNING SEE PRODUCT WARNING ON PAGE 103

This device is of an application specific design. Please Contact LINEMASTER® for additional Information: 1-860-974-1000

NEMA Type

Classified to IEC/UL 60601.1

Classified to Can/CSA C22.2 No. 60601.1

EN 60529 Degree of Protection IP68 (Transmitter Only)

EN 60529 Degree of Protection IPX1 (Receiver Only)

Meets EMC Directive EN60601-1-2

Federal Communications Commission (FCC) Compliant

Drip tight • Dust tight • Watertight • Oil tight •

Rust Proof • Corrosion Resistant

DIGITAL RF WIRELESS DEVICE



Materials of Construction:

- Switch Functions: Maximum combinations of 5
- Mode change switch available
- Transmitter battery life: 700 hours @ 50% duty cycle typical
- Power Consumption (Transmitter): Stand-by 2ua
- Standard Power Requirements (Receiver): 6VDC @ 200ma (other voltages optional)
- Transmitter low battery indicator
- Receiver output: SPST relay, 0.5 amp contacts; SPDT relays optional
- Receiver switch activation indicator(s)
- High impact plastic wiring channel and receiver housing

Features & Benefits:

- 2.405 - 2.480 GHz, Channels 1-15
- 802.15.4 Compliant
- Meets IEC 60601 3rd Edition
- Automatic RF power level adjustment of Transmitter
- Waterproof - IP68 degree of protection for foot pedal (Transmitter)
- IPX1 degree of protection for Receiver
- 50 foot range typical
- Typical Latency: < 65ms
- Uses industry standard AA Alkaline batteries
- Eliminates the need for cords
- Retrofits most existing equipment
- No product calibration required – plug and go
- Submersible transmitter for easy cleaning

Options:

- Protective bag available for easy clean-up

Transmitter (Switch)	
Size (HxWxD):	2.63 x 21.00 x 10.93 In.
Weight:	7.50 lbs. with batteries
Receiver	
Size (HxWxD):	2.25 x 5.00 x 3.50 In.
Weight:	.45 lbs.
For Dimension Drawings visit www.linemaster.com and click on Line Drawings located under the Guides & Literature Tab	

Classified to IEC/UL Medical Electrical Equipment by Underwriter's Laboratories, Inc. with respect to fire, shock, and mechanical hazards in accordance with IEC/UL 60601.1

Classified with respect to electric shock, fire, mechanical, and other specified hazards only, in accordance with Can/CSA C22.2 No. 60601.1

Meets EMC Directive EN60601-1-2

WARNING SEE PRODUCT WARNING ON PAGE 103

This device is of an application specific design. Please Contact LINEMASTER® for additional Information: 1-860-974-1000



Infrared Wireless Digital - Single

NEMA Type
Classified to IEC/UL 60601.1
Classified to Can/CSA C22.2 No. 60601.1
EN 60529 Degree of Protection IP68 (Transmitter Only)
EN 60529 Degree of Protection IPX1 (Receiver Only)
Meets EMC Directive EN60601-1-2
Food & Drug Administration (FDA) 510K Clearance

Drip tight • Dust tight • Watertight • Oil tight • Rust Proof • Corrosion Resistant
DIGITAL IR WIRELESS DEVICE

Materials of Construction:

- Switch Functions: Maximum combinations of 5
- Up to 4 systems can be operating at the same time in the same room
- Mode change switch available
- Transmitter battery life: 200 hours @ 50% duty cycle typical
- Power Consumption (Transmitter): Stand-by 100ua
- Standard Power Requirements (Receiver): 6VDC @ 200ma (other voltages optional)
- Transmitter low battery indicator
- Receiver output: SPST relay, 0.5 amp contacts; SPDT relays optional
- Receiver switch activation indicator(s)
- Non Line-of-Sight Multi-Directional infrared transmission, 360 degree coverage
- Protective Dual Layer Signal eliminates cross talk

Features & Benefits:

- 40 foot range typical
- Uses industry standard AA Alkaline batteries
- Eliminates the need for cords
- Retrofits most existing equipment
- Meets IEC 60601 3rd Edition
- No product calibration required – plug and go
- Submersible transmitter for easy cleaning

Options:

- Protective bag available for easy clean-up
- Battery Powered Receiver optional

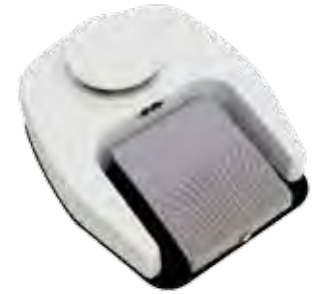

Transmitter (Switch)	
Size (HxWxD):	3.07 x 8.09 x 8.93 In.
Weight:	3.70 lbs. with batteries
Receiver (Standard)	
Size (HxWxD):	2.75 x 5.00 x 3.50 In.
Weight:	.45 lbs.
Receiver (Battery Powered)	
Size (HxWxD):	5.50 x 5.25 x 4.50 In.
Weight:	1.70 lbs.
<i>For Dimension Drawings visit www.linemaster.com and click on Line Drawings located under the Guides & Literature Tab</i>	



Classified to IEC/UL Medical Electrical Equipment by Underwriter's Laboratories, Inc. with respect to fire, shock, and mechanical hazards in accordance with IEC/UL 60601.1

Classified with respect to electric shock, fire, mechanical, and other specified hazards only, in accordance with Can/CSA C22.2 No. 60601.1

Meets EMC Directive EN60601-1-2

⚠ WARNING PLASMA VIDEO DISPLAYS CAN SERIOUSLY AFFECT THE OPERATION OF THIS DEVICE. PLASMA VIDEO DISPLAYS CAN INCREASE THE SWITCH ACTIVATION TIMES SIGNIFICANTLY OR PREVENT SWITCH OPERATION ALTOGETHER. DO NOT USE IN THE VICINITY OF PLASMA VIDEO DISPLAYS.

⚠ WARNING SEE PRODUCT WARNING ON PAGE 103
 This device is of an application specific design. Please Contact LINEMASTER® for additional Information: 1-860-974-1000

NEMA Type

Classified to IEC/UL 60601.1

Classified to Can/CSA C22.2 No. 60601.1

EN 60529 Degree of Protection IP68 (Transmitter Only)

EN 60529 Degree of Protection IPX1 (Receiver Only)

Meets EMC Directive EN60601-1-2

Food & Drug Administration (FDA) 510K Clearance

Drip tight • Dust tight • Watertight • Oil tight • Rust Proof • Corrosion Resistant

DIGITAL IR WIRELESS DEVICE

Materials of Construction:

- Switch Functions: Maximum combinations of 5
- Up to 4 systems can be operating at the same time in the same room
- Mode change switch available
- Transmitter battery life: 200 hours @ 50% duty cycle typical
- Power Consumption (Transmitter): Stand-by 100ua
- Standard Power Requirements (Receiver): 6VDC @ 200ma (other voltages optional)
- Transmitter low battery indicator
- Receiver output: SPST relay, 0.5 amp contacts; SPDT relays optional
- Receiver switch activation indicator(s)
- Non Line-of-Sight Multi-Directional infrared transmission, 360 degree coverage
- Protective Dual Layer Signal eliminates cross talk

Features & Benefits:

- 40 foot range typical
- Uses industry standard AA Alkaline batteries
- Eliminates the need for cords
- Retrofits most existing equipment
- Meets IEC 60601 3rd Edition
- No product calibration required – plug and go
- Submersible transmitter for easy cleaning

Options:

- Protective bag available for easy clean-up
- Battery Powered Receiver optional



Transmitter (Switch)	
Size (HxWxD):	3.07 x 14.00 x 9.41 In.
Weight:	5.50 lbs. with batteries
Receiver (Standard)	
Size (HxWxD):	2.75 x 5.00 x 3.50 In.
Weight:	.45 lbs.
Receiver (Battery Powered)	
Size (HxWxD):	5.50 x 5.25 x 4.50 In.
Weight:	1.70 lbs.
For Dimension Drawings visit www.linemaster.com and click on Line Drawings located under the Guides & Literature Tab	



Classified to IEC/UL Medical Electrical Equipment by Underwriter's Laboratories, Inc. with respect to fire, shock, and mechanical hazards in accordance with IEC/UL 60601.1

Classified with respect to electric shock, fire, mechanical, and other specified hazards only, in accordance with Can/CSA C22.2 No. 60601.1

Meets EMC Directive EN60601-1-2

WARNING

PLASMA VIDEO DISPLAYS CAN SERIOUSLY AFFECT THE OPERATION OF THIS DEVICE. PLASMA VIDEO DISPLAYS CAN INCREASE THE SWITCH ACTIVATION TIMES SIGNIFICANTLY OR PREVENT SWITCH OPERATION ALTOGETHER. DO NOT USE IN THE VICINITY OF PLASMA VIDEO DISPLAYS.

WARNING SEE PRODUCT WARNING ON PAGE 103

This device is of an application specific design. Please Contact LINEMASTER® for additional Information: 1-860-974-1000



Infrared Wireless Digital - Triple

NEMA Type
Classified to IEC/UL 60601.1
Classified to Can/CSA C22.2 No. 60601.1
EN 60529 Degree of Protection IP68 (Transmitter Only)
EN 60529 Degree of Protection IPX1 (Receiver Only)
Meets EMC Directive EN60601-1-2
Food & Drug Administration (FDA) 510K Clearance



Drip tight • Dust tight • Watertight • Oil tight • Rust Proof • Corrosion Resistant
DIGITAL IR WIRELESS DEVICE

Materials of Construction:

- Switch Functions: Maximum combinations of 5
- Up to 4 systems can be operating at the same time in the same room
- Mode change switch available
- Transmitter battery life: 200 hours @ 50% duty cycle typical
- Power Consumption (Transmitter): Stand-by 100ua
- Standard Power Requirements (Receiver): 6VDC @ 200ma (other voltages optional)
- Transmitter low battery indicator
- Receiver output: SPST relay, 0.5 amp contacts; SPDT relays optional
- Receiver switch activation indicator(s)
- Non Line-of-Sight Multi-Directional infrared transmission, 360 degree coverage
- Protective Dual Layer Signal eliminates cross talk



Features & Benefits:

- 40 foot range typical
- Uses industry standard AA Alkaline batteries
- Eliminates the need for cords
- Retrofits most existing equipment
- Meets IEC 60601 3rd Edition
- No product calibration required – plug and go
- Submersible transmitter for easy cleaning

Options:

- Protective bag available for easy clean-up
- Battery Powered Receiver optional



Transmitter (Switch)	
Size (HxWxD):	3.07 x 21.00 x 10.93 In.
Weight:	7.50 lbs. with batteries
Receiver (Standard)	
Size (HxWxD):	2.75 x 5.00 x 3.50 In.
Weight:	.45 lbs.
Receiver (Battery Powered)	
Size (HxWxD):	5.50 x 5.25 x 4.50 In.
Weight:	1.70 lbs.
<i>For Dimension Drawings visit www.linemaster.com and click on Line Drawings located under the Guides & Literature Tab</i>	

Classified to IEC/UL Medical Electrical Equipment by Underwriter's Laboratories, Inc. with respect to fire, shock, and mechanical hazards in accordance with IEC/UL 60601.1

Classified with respect to electric shock, fire, mechanical, and other specified hazards only, in accordance with Can/CSA C22.2 No. 60601.1

Meets EMC Directive EN60601-1-2



WARNING PLASMA VIDEO DISPLAYS CAN SERIOUSLY AFFECT THE OPERATION OF THIS DEVICE. PLASMA VIDEO DISPLAYS CAN INCREASE THE SWITCH ACTIVATION TIMES SIGNIFICANTLY OR PREVENT SWITCH OPERATION ALTOGETHER. DO NOT USE IN THE VICINITY OF PLASMA VIDEO DISPLAYS.

WARNING SEE PRODUCT WARNING ON PAGE 103

This device is of an application specific design. Please Contact LINEMASTER® for additional Information: 1-860-974-1000

NEMA Type

Classified to IEC/UL 60601.1

Classified to Can/CSA C22.2 No. 60601.1

EN 60529 Degree of Protection IP68 (Transmitter Only)

EN 60529 Degree of Protection IPX1 (Receiver Only)

Meets EMC Directive EN60601-1-2

Drip tight • Dust tight • Watertight • Oil tight

LINEAR IR WIRELESS DEVICE

Materials of Construction:

- Switch Functions: Maximum combinations of 5, up to 3 linear and 3 digital switch functions
- Up to 4 systems can be operating at the same time in the same room
- Transmitter battery life: 150-200 hours @ 50% duty cycle typical
- Power Consumption (Transmitter): Stand-by 250ua
- Standard Power Requirements (Receiver): 12VDC @ 200ma
- Transmitter low battery indicator
- Uses industry standard AA Alkaline batteries
- Range: Typically 40 feet
- Linear receiver output voltage is customer specified with 12VDC maximum output (other voltages optional)
- Receiver switch activation indicator(s)
- Non Line-of-Sight Multi-Directional infrared transmission, 360 degree coverage
- Exceptional linear control - smooth and responsive
- New custom designed foot pedal
- Uses Hall Effect sensors:
High reliability, No mechanical interface,
High linearity, No dead spots
- Submersible transmitter for easy cleaning
- Eliminates the need for cords
- Retro-fits most existing equipment
- No product calibration required – plug and go



Features & Benefits:

- 40 foot range typical
- Uses industry standard AA Alkaline batteries
- Eliminates the need for cords
- Retrofits most existing equipment
- Meets IEC 60601 3rd Edition
- No product calibration required – plug and go
- Submersible transmitter for easy cleaning

Options:

- Protective bag available for easy clean-up

Transmitter (Switch)	
Size (HxWxD):	3.07 x 8.09 x 8.93 In.
Weight:	3.70 lbs. with batteries
Receiver	
Size (HxWxD):	2.75 x 5.00 x 3.50 In.
Weight:	.45 lbs.

For Dimension Drawings visit www.linemaster.com and click on Line Drawings located under the Guides & Literature Tab



WARNING PLASMA VIDEO DISPLAYS CAN SERIOUSLY AFFECT THE OPERATION OF THIS DEVICE. PLASMA VIDEO DISPLAYS CAN INCREASE THE SWITCH ACTIVATION TIMES SIGNIFICANTLY OR PREVENT SWITCH OPERATION ALTOGETHER. DO NOT USE IN THE VICINITY OF PLASMA VIDEO DISPLAYS.

WARNING SEE PRODUCT WARNING ON PAGE 103

This device is of an application specific design. Please Contact LINEMASTER® for additional Information: 1-860-974-1000



NEMA Type
Classified to IEC/UL 60601.1
Classified to Can/CSA C22.2 No. 60601.1
EN 60529 Degree of Protection IP68 (Transmitter Only)
EN 60529 Degree of Protection IPX1 (Receiver Only)
Meets EMC Directive EN60601-1-2



Drip tight • Dust tight • Watertight • Oil tight
LINEAR IR WIRELESS DEVICE

Materials of Construction:

- Switch Functions: Maximum combinations of 5, up to 3 linear and 3 digital switch functions
- Up to 4 systems can be operating at the same time in the same room
- Transmitter battery life: 150-200 hours @ 50% duty cycle typical
- Power Consumption (Transmitter): Stand-by 250ua
- Standard Power Requirements (Receiver): 12VDC @ 200ma
- Transmitter low battery indicator
- Uses industry standard AA Alkaline batteries
- Range: Typically 40 feet
- Linear receiver output voltage is customer specified with 12VDC maximum output (other voltages optional)
- Receiver switch activation indicator(s)
- Non Line-of-Sight Multi-Directional infrared transmission, 360 degree coverage
- Exceptional linear control - smooth and responsive
- New custom designed foot pedal
- Uses Hall Effect sensors:
High reliability, No mechanical interface,
High linearity, No dead spots
- Submersible transmitter for easy cleaning
- Eliminates the need for cords
- Retro-fits most existing equipment
- No product calibration required – plug and go

Features & Benefits:

- 40 foot range typical
- Uses industry standard AA Alkaline batteries
- Eliminates the need for cords
- Retrofits most existing equipment
- Meets IEC 60601 3rd Edition
- No product calibration required – plug and go
- Submersible transmitter for easy cleaning

Options:

- Protective bag available for easy clean-up

Transmitter (Switch)	
Size (HxWxD):	3.07 x 14.00 x 9.41 In.
Weight:	5.50 lbs. with batteries
Receiver	
Size (HxWxD):	2.75 x 5.00 x 3.50 In.
Weight:	.45 lbs.

For Dimension Drawings visit www.linemaster.com and click on Line Drawings located under the Guides & Literature Tab



WARNING PLASMA VIDEO DISPLAYS CAN SERIOUSLY AFFECT THE OPERATION OF THIS DEVICE. PLASMA VIDEO DISPLAYS CAN INCREASE THE SWITCH ACTIVATION TIMES SIGNIFICANTLY OR PREVENT SWITCH OPERATION ALTOGETHER. DO NOT USE IN THE VICINITY OF PLASMA VIDEO DISPLAYS.

WARNING SEE PRODUCT WARNING ON PAGE 103

This device is of an application specific design. Please Contact LINEMASTER® for additional Information: 1-860-974-1000

NEMA Type

Classified to IEC/UL 60601.1

Classified to Can/CSA C22.2 No. 60601.1

EN 60529 Degree of Protection IP68 (Transmitter Only)

EN 60529 Degree of Protection IPX1 (Receiver Only)

Meets EMC Directive EN60601-1-2

Drip tight • Dust tight • Watertight • Oil tight

LINEAR IR WIRELESS DEVICE



Materials of Construction:

- Switch Functions: Maximum combinations of 5, up to 3 linear and 3 digital switch functions
- Up to 4 systems can be operating at the same time in the same room
- Transmitter battery life: 150-200 hours @ 50% duty cycle typical
- Power Consumption (Transmitter): Stand-by 250ua
- Standard Power Requirements (Receiver): 12VDC @ 200ma
- Transmitter low battery indicator
- Uses industry standard AA Alkaline batteries
- Range: Typically 40 feet
- Linear receiver output voltage is customer specified with 12VDC maximum output (other voltages optional)
- Receiver switch activation indicator(s)
- Non Line-of-Sight Multi-Directional infrared transmission, 360 degree coverage
- Exceptional linear control - smooth and responsive
- New custom designed foot pedal
- Uses Hall Effect sensors:
 - High reliability, No mechanical interface,
 - High linearity, No dead spots
- Submersible transmitter for easy cleaning
- Eliminates the need for cords
- Retro-fits most existing equipment
- No product calibration required – plug and go

Features & Benefits:

- 40 foot range typical
- Uses industry standard AA Alkaline batteries
- Eliminates the need for cords
- Retrofits most existing equipment
- Meets IEC 60601 3rd Edition
- No product calibration required – plug and go
- Submersible transmitter for easy cleaning

Options:

- Protective bag available for easy clean-up

Transmitter (Switch)	
Size (HxWxD):	3.07 x 21.00 x 11.00 In.
Weight:	7.50 lbs. with batteries
Receiver	
Size (HxWxD):	2.75 x 5.00 x 3.50 In.
Weight:	.45 lbs.

For Dimension Drawings visit www.linemaster.com and click on Line Drawings located under the Guides & Literature Tab

⚠️ WARNING

PLASMA VIDEO DISPLAYS CAN SERIOUSLY AFFECT THE OPERATION OF THIS DEVICE. PLASMA VIDEO DISPLAYS CAN INCREASE THE SWITCH ACTIVATION TIMES SIGNIFICANTLY OR PREVENT SWITCH OPERATION ALTOGETHER. DO NOT USE IN THE VICINITY OF PLASMA VIDEO DISPLAYS.

⚠️ WARNING SEE PRODUCT WARNING ON PAGE 103

This device is of an application specific design. Please Contact LINEMASTER® for additional Information: 1-860-974-1000

FULL SHIELD

CATALOG NUMBER: 534-Z24

- Cast Aluminum Alloy construction
- Resistant to impact
- Opening designed to easily accommodate most footwear
- Standard color is high visibility alert orange
- Special variations available in production quantities
- Entire foot switch is covered
- Accepts wide range of foot switch models

Size (HxWxD):	4.37 x 5.87 x 8.72 In.
Weight:	2.00 lb.

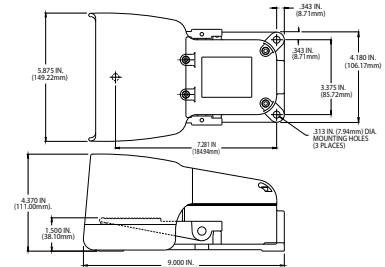

"O" SHIELD

CATALOG NUMBER: 534-A25

- Cast Aluminum Alloy construction
- Resistant to impact
- Opening designed to easily accommodate most footwear
- Standard color is high visibility alert orange
- Special variations available in production quantities
- Entire foot switch is covered
- Accepts wide range of foot switch models

Size (HxWxD):	5.03 x 6.03 x 8.72 In.
Weight:	2.25 lb.

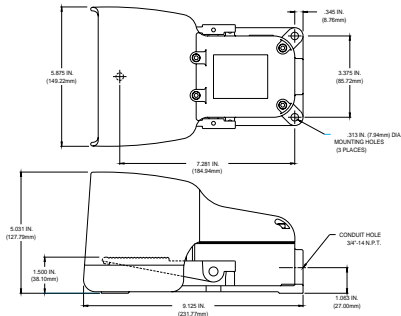

"OX" SHIELD

CATALOG NUMBER: 534-B25

- Cast Aluminum Alloy construction
- Resistant to impact
- Opening designed to easily accommodate most footwear
- Standard color is high visibility alert orange
- Special variations available in production quantities
- Entire foot switch is covered
- Accepts wide range of foot switch models

Size (HxWxD):	5.78 x 6.03 x 8.72 In.
Weight:	2.50 lb.

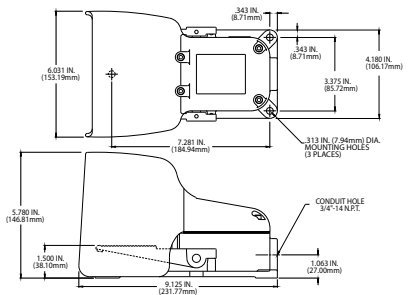

Accessories - Awareness Cover

AWARENESS COVER

CATALOG NUMBER: 522-U37 (ORANGE) AND 522-U37-1 (GRAY)

- Alerts you to the location of the foot switch
- Watch for tripping hazards
- Accepts wide range of foot switch models
- Resistant to impact
- Ergonomic design to accommodate most footwear
- Non-corrosive material
- Exceptional value and quality
- Standard color is high visibility alert orange
- Special variations available in production quantities
- Complete with non-skid feet
- Opening is large and easy to access
- Versatile and Lightweight
- Entire foot switch is covered

Size (HxWxD):	5.72 x 6.05 x 5.28 In.
Weight:	8.50 oz.

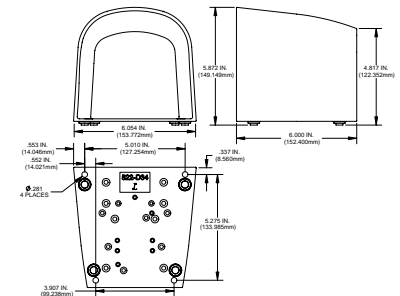

Accessories - Guards

FULL GUARD

CATALOG NUMBER: 522-B14

- Heavy gage rolled steel and welded construction
- Resistant to impact
- Opening designed to easily accommodate most footwear
- Standard color is high visibility alert orange
- Special variations available in production quantities
- Complete with non-skid feet
- Entire foot switch is covered
- Accepts wide range of foot switch models

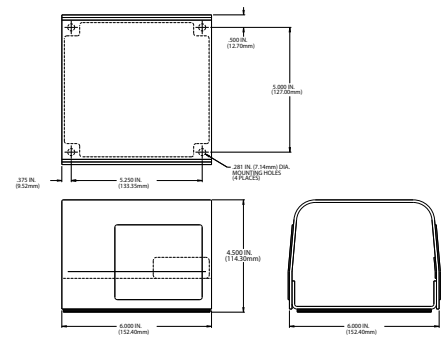

Size (HxWxD):	4.50 x 6.00 x 6.00 In.
Weight:	4.50 lbs.

FULL TWIN GUARD

CATALOG NUMBER: 522-B12

- Heavy gage rolled steel and welded construction
- Resistant to impact
- Opening designed to easily accommodate most footwear
- Standard color is high visibility alert orange
- Special variations available in production quantities
- Complete with non-skid feet
- Entire foot switch is covered
- Accepts wide range of foot switch models

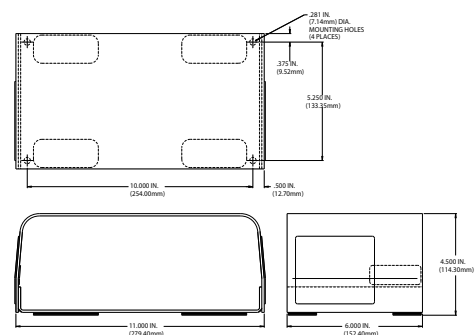

Size (HxWxD):	4.50 x 11.00 x 6.00 In.
Weight:	6.75 lbs.

SINGLE OVERSIZED GUARD

CATALOG NUMBER: 522-F28

- Heavy gage rolled steel and welded construction
- Resistant to impact
- Opening designed to easily accommodate protective footwear
- Standard color is high visibility alert orange
- Special variations available in production quantities
- Complete with non-skid feet
- Entire foot switch is covered
- Accepts wide range of foot switch models

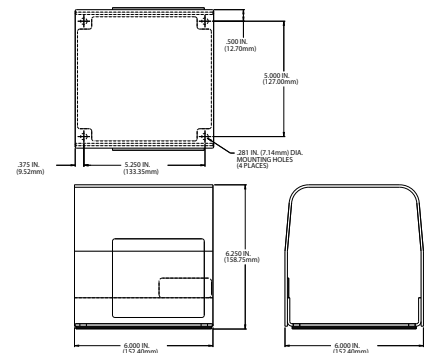

Size (HxWxD):	6.25 x 6.00 x 6.00 In.
Weight:	5.00 lbs.

OVERSIZED TWIN GUARD

CATALOG NUMBER: : 522-D28

- Heavy gage rolled steel and welded construction
- Resistant to impact
- Opening designed to easily accommodate protective footwear
- Standard color is high visibility alert orange
- Special variations available in production quantities
- Complete with non-skid feet
- Entire foot switch is covered
- Accepts wide range of foot switch models

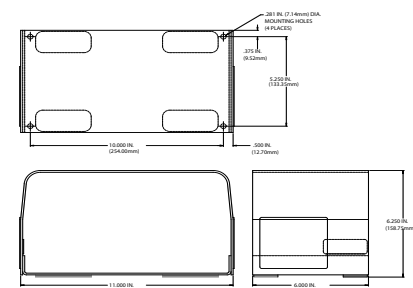

Size (HxWxD):	6.25 x 11.00 x 6.00 In.
Weight:	7.00 lbs.

FULL GUARD STAINLESS STEEL
CATALOG NUMBER: 522 - K26

- Heavy gage Brushed Stainless Steel and welded construction
- Resistant to impact
- Opening designed to easily accommodate protective footwear
- Special variations available in production quantities
- Complete with non-skid feet
- Entire foot switch is covered
- Accepts wide range of foot switch models

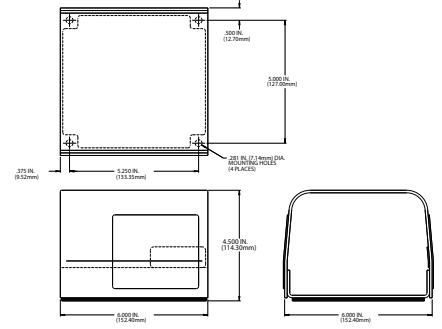

Size (HxWxD):	4.50 x 6.00 x 6.00 In.
Weight:	3.50 lbs.

MEDICAL GUARD
CATALOG NUMBER: 997-Z26

- Cast Aluminum Housing with steel base plate construction
- Resistant to impact
- Opening designed to easily accommodate protective footwear
- Special variations available in production quantities
- Complete with non-skid feet
- Entire foot switch is covered
- Accepts wide range of foot switch models

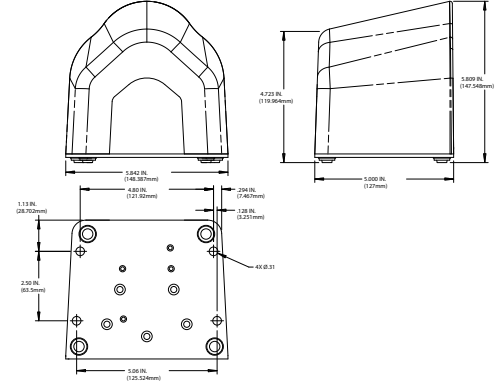

Size (HxWxD):	5.50 x 5.00 x 5.85 In.
Weight:	3.00 lbs.

Accessories - Protective Boot

PROTECTIVE BOOT
CATALOG NUMBER: 522-N30 (ORANGE) AND 522-N30-1 (BLACK)

- Plastisol PVC material in bright orange
- Easy to apply over Clipper & Clipper 88 foot switches.
- No special tools required
- Prevents materials in wet or dirty environments from entering the housing
- Not available for wide-treadle models.
- Note: Requires Modification when used with Full Guard. Please contact factory for details.

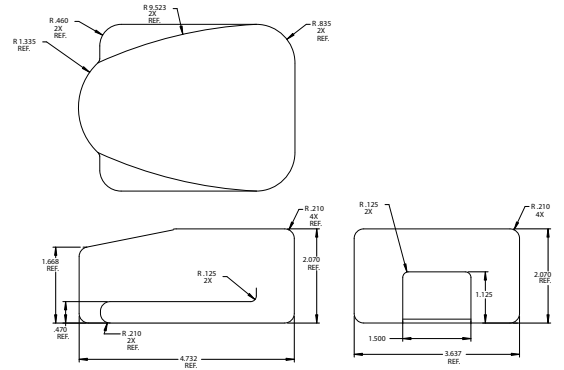

Size (HxWxD):	2.07 x 4.74 x 3.64 In.
Weight:	3.10 oz.

Stock Cordsets with Molded Plug

Do you want to receive your LINEMASTER® foot switch complete with a cordset attached?

Do you have a requirement for a special cordset assembly?

Custom cordset service is a specialty at LINEMASTER®, that is offered to the Original Equipment Manufacturer on a direct basis. Special cordsets are available to the O.E.M. as a separate item or as part of a complete foot switch assembly.

LINEMASTER® will manufacture special cordsets to the Original Equipment Manufacturer's specifications. Whether it be with one of our molded-on plugs or an attached type connector by another manufacturer, we will be happy to submit a quotation. We will also use any cable, as specified by the customer. If you have requirements for a special cordset, please consider LINEMASTER® as your source and give us your complete specifications.

The selection of an interfacing connector should not precede the selection of the cable. The abuse factor may require that a heavier cable construction type be selected that can be accommodated in a desired interfacing connector. A small size connector may be desirable, but not at the price of unnecessary field problems due to an unsuitable cable selection.

Another design consideration is that the cable be provided with a suitable strain relief where the cable enters the foot switch housing. For most non-watertight applications, LINEMASTER® offers a high quality, molded on, cable strain relief grommet. When adjustable, two screw, cable clamps are used, a flexible bushing can be added over the cable, when required to give added cable strain relief or flex protection. In watertight applications, a properly sized, watertight, cable strain relief connector should be specified to maintain the integrity of the watertight seal where the cable enters the foot switch housing.

Replacement Cables	Image	Catalog Number	Lgth (ft.)	Gauge	Material	Color	Max. Cable Dia. (IN)	Compatible Socket
		SF-524-M	6	18-3	SJT	Black	.314	Any Standard 3 Prong 125 VAC Wall Receptacle
		SF-515-P34	8	18-3	SJT		.312	
		SF-536-P	8	16-3	SJT		.331	
		SF-522-Q17	8	14-3	SJT		.355	
		SF-965-JJ	8	22-1	PVC Jacket Shielded Audio	Black	.315	Any Standard 2 Contact .250 dia. Miniature phone plug receptacle
		SF-515-D16	8	22-1	PVC Jacket Shielded Audio	Black	.150	Any Standard 2 Contact .140 dia. Miniature phone plug receptacle
		SF-515-A10	8	22-1	PVC Jacket Shielded Audio	Black	.150	Any Standard 2 Contact .097 dia. Miniature phone plug receptacle

Custom cordset service is a specialty at LINEMASTER®, that is offered to the Original Equipment Manufacturer on a direct basis. Special cordsets are available to the O.E.M. as a separate item or as part of a complete foot switch assembly.

LINEMASTER® will manufacture special cordsets to the Original Equipment Manufacturer's specifications. Whether it be with one of our molded-on plugs or an attached type connector by another manufacturer, we will be happy to submit a quotation. We will also use any cable, as specified by the customer. If you have requirements for a special cordset, please consider LINEMASTER® as your source and give us your complete specifications.

The selection of an interfacing connector should not precede the selection of the cable. The abuse factor may require that a heavier cable construction type be selected that can be accommodated in a desired interfacing connector. A small size con-

necter may be desirable, but not at the price of unnecessary field problems due to an unsuitable cable selection.

Another design consideration is that the cable be provided with a suitable strain relief where the cable enters the foot switch housing. For most non-watertight applications, LINEMASTER® offers a high quality, molded on, cable strain relief grommet. When adjustable, two screw, cable clamps are used, a flexible bushing can be added over the cable, when required to give added cable strain relief or flex protection. In watertight applications, a properly sized, watertight, cable strain relief connector should be specified to maintain the integrity of the watertight seal where the cable enters the foot switch housing.

Cord Type	Jacket Material	AWG Size	Electrical Rating In Amperes	UL/CSA Dia. Range (IN)	Applications
300 Volt	SJT-plastic SJO-neoprene SJTO-plastic	18-2	10	.280-.315	Sound equipment, small motors, tools, medical & dental equipment, office machines, tape recorders, and other small appliances. Widely used on foot switches. SJO (Neoprene) or SJTO (Plastic) cord is used where cord must resist oil, acid, and grease.
		18-3	10	.300-.335	
		18-4	7	.325-.365	
		16-2	13	.305-.340	
		16-3	13	.325-.360	
		16-4	10	.350-.395	
300 Volt	SVT-plastic SVO-neoprene SVTO-plastic	18-2	10	.220-.255	Office equipment (dictating machines) and other light duty requirements. SVO (Neoprene) or SVTO (Plastic) cord is used where cord must resist oil, acid, and grease.
		18-3	10	.230-.265	
		18-4	7	.250-.290	
600 Volt	ST-plastic SO-neoprene STO-plastic	18-2	10	.340-.385	Heavy duty service when subjected to extra hard usage, heavy tools, medical & dental equipment, and other heavy duty applications. SO (Neoprene) or STO (Plastic) cord is used where cord must resist oil, acid, and grease. Note: ST (Plastic) cord is slightly smaller in diameter than SO (Neoprene) or S (Rubber) cord.
		18-3	10	.360-.400	
		18-4	7	.385-.430	
		16-2	13	.365-.410	
		16-3	13	.385-.430	
		16-4	10	.410-.460	
		14-2	18	.495-.550	
		14-3	18	.520-.575	
		14-4	13	.560-.620	

IP Explanation and Ratings

EN 60529 outlines an international classification system for the sealing effectiveness of enclosures of electrical equipment against the intrusion into the equipment of foreign bodies (i.e. tools, dust, fingers) and moisture. This classification system utilizes the letters "IP" ("Ingress Protection") followed by two or three digits. (A third digit is sometimes used. An "x" is used for one of the digits if there is only one class of protection; i.e. IPX4 which addresses moisture resistance only.)

Degrees of Protection - First Digit

The first digit of the IP code indicates the degree that persons are protected against contact with moving parts (other than smooth rotating shafts, etc.) and the degree that equipment is protected against solid foreign bodies intruding into an enclosure.

- 0 No special protection
- 1 Protection from a large part of the body such as a hand (but no protection from deliberate access); from solid objects greater than 50mm in diameter.
- 2 Protection against fingers or other object not greater than 80mm in length and 12mm in diameter.
- 3 Protection from entry by tools, wires, etc., with a diameter of thickness greater than 1.0mm.
- 4 Protection from entry by solid objects with a diameter or thickness greater than 1.0mm
- 5 Protection from the amount of dust that would interfere with the operation of the equipment.
- 6 Dust tight.













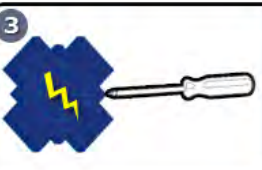

Degrees of Protection - Second Digit

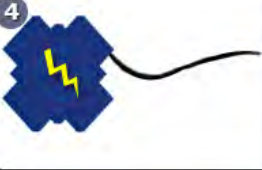
The second digit indicates the degree of protection of the equipment inside the enclosure against the harmful entry of various forms of moisture (e.g. dripping, spraying, submersion, etc.)









- 0 No special protection
- 1 Protection from dripping water.
- 2 Protection from vertically dripping water.
- 3 Protection from sprayed water.
- 4 Protection from splashed water.
- 5 Protection from water projected from a nozzle
- 6 Protection against heavy seas, or powerful jets of water.
- 7 Protection against immersion.
- 8 Protection against complete, continuous submersion in water.



Submersion depth and time must be specified by the end-user. The requirement must be more onerous than IP67

IP RATINGS CHART

IP	EXAMPLE	SOLID PROTECTION	IP	EXAMPLE	LIQUID PROTECTION
1		Protected against a solid object greater than 50mm, such as a hand	1		Protected against vertically falling drops of water. Limited ingress permitted
2		Protected against a solid object greater than 12.5mm, such as a finger	2		Protected against vertically falling drops of water w/ enclosure tilted 15° from vertical. Limited ingress permitted
3		Protected against a solid object greater than 2.5mm, such as a scredriver	3		Protected against sprays to 60° from the vertical. Limited ingress permitted
4		Protected against a solid object greater than 1.0mm, such as a wire	4		Protected against water splashed from all directions. Limited ingress permitted
5		Dust Protected. Limited ingress of dust permitted	5		Protected against jets of water. Limited ingress permitted
6		Dust Tight. Zero ingress of dust permitted	6		Protected against strong jets of water. Limited ingress permitted
			7		Protected against the effects of immersion between 15cm and 1m
			8		Protected against long periods of immersion under pressure



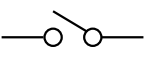

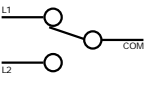
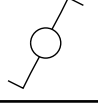
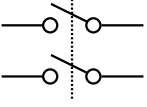
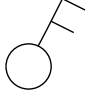
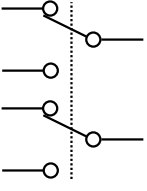
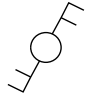
Agency Markings & Approvals

Symbol	Country	Description
	Switzerland	SEV Accepted Schweizerischer Electrotechnischer Verein (SEV) is the certification agency for Switzerland. The recognized association for Swiss standards is the Swiss Standards Association (SEV). The SEV has adopted IEC standards almost without exception. The SEV mark molded into a plug or connector indicates that a product has been tested and approved for use in Switzerland. All products to be sold in Switzerland must bear this mark.
	Europe	AP Marked For anesthesia products utilized in anesthesia areas apply special requirements. For these extremely sensible range of use we offer control devices suitable as approved anesthesia product for surgical applications (class AP). This is documented with the AP mark. On medical equipment, to mark a category AP equipment complying with IEC Publication 601 which also specifies the way in which this symbol has to be used.
	Europe	CE MARKED CE Marking on a product is a manufacturer's declaration that the product complies with the essential requirements of the relevant European health, safety and environmental protection legislation, in practice by many of the so-called Product Directives.
	Canada	CSA Certified A CSA mark on its own, without indicators, means that the product is certified primarily for the Canadian market, to the applicable Canadian standards. If a product has features from more than one area, (e.g. electrical equipment with fuel burning features), the mark indicates compliance to all applicable Standards.
	Denmark	DEMKO Recognized Component UL International Demko A/S certificate and the D-Mark The D-Mark signals to consumers, retailers, insurers and authorities that a reputable, independent third-party and European National Certification body has tested the product to appropriate international, electrical safety standards. The D-Mark is a voluntary safety mark registered and provided by UL-Demko. It has been in use for more than 70 years and is a familiar symbol to consumers as well as retailers and manufacturers in Europe.
	Germany	TUV BAUART TÜV is NRTL (Nationally Recognized Testing Laboratory) and SCC certified, providing a full suite of services, including CE Marking assistance, electromagnetic compatibility (EMC), electrical & mechanical testing, and many additional global conformity assessment services that help companies gain product compliance to enter individual country markets.
	United States	UL Mark / UL Listing Mark This is one of the most common UL Marks. If a product carries this Mark, it means UL found that representative samples of this product met UL's safety requirements. These requirements are primarily based on UL's own published Standards for Safety. This type of Mark is seen commonly on appliances and computer equipment, furnaces and heaters, fuses, electrical panelboards, smoke and carbon monoxide detectors, fire extinguishers and sprinkler systems, personal flotation devices like life jackets and life preservers, bullet resistant glass, and thousands of other products.
	United States & Canada	UL Mark for Canada and the United States C-UL US Listing Mark UL introduced this new Listing Mark in early 1998. It indicates compliance with both Canadian and U.S. requirements. The Canada/U.S. UL Mark is optional. UL encourages those manufacturers with products certified for both countries to use this new, combined Mark, but they may continue using separate UL Marks for the United States and Canada.
	United States	UL Recognized Component Mark Recognized Component Mark This is a mark consumers rarely see because it is specifically used on component parts that are part of a larger product or system. These components may have restrictions on their performance or may be incomplete in construction. The Component Recognition marking is found on a wide range of products, including some switches, power supplies, printed wiring boards, some kinds of industrial control equipment and thousands of other products.
	United States & Canada	UL Recognized Component Mark for Canada and the United States Recognized Component Mark for Canada and the United States This new UL Recognized Component Mark, which became effective April 1, 1998, may be used on components certified by UL to both Canadian and U.S. requirements. Although UL had not originally planned to introduce a combined Recognized Component Mark, the popularity of the Canada/U.S. Listing and Classification Marks among clients with UL certifications for both Canada and the United States has led to the new Mark.
	International	Symbol for WEEE Compliance The WEEE Directive 2002/96/EC, was issued by the European Union in 2003 to minimize the impact of electrical and electronic equipment on the environment throughout their life cycle including when they become waste. It makes producers of WEEE responsible for financing the collection, treatment, recycling and recovery of electrical and electronic equipment waste. Equipment includes, but is not limited to, information technology and telecommunications equipment, household appliances, lighting equipment, electrical and electronic tools, etc. European Union member countries are in the process of implementing measures to comply with this directive.
	International	RoHS RoHS stands for Restriction of the use of certain Hazardous Substances in Electrical and Electronic Equipment. In conjunction with the WEEE directive, the European Union issued directive 2002/95/EC on the restriction of the use of certain hazardous substances in electrical and electronic equipment. In summary, this directive bans or in some situations limits the following toxic chemicals after the 1st of July 2003: lead, mercury, cadmium, Hexavalent chromium, polybrominated biphenyls (PBB) or polybrominated diphenyl ethers (PBDE).
	United States	Food & Drug Administration US Federal Government agency whose mission is "to promote and protect the public health by helping safe and effective products reach the market in a timely way, and monitoring products for continued safety after they are in use."
	United States	The Federal Communications Commission The Federal Communications Commission regulates interstate and international communications by radio, television, wire, satellite and cable in all 50 states, the District of Columbia and U.S. territories.
	United States	The ETL Listed Mark is proof of product compliance (electrical, gas and other safety standards) to North American safety standards. A product bearing the ETL Listed Mark is determined to have met the minimum requirements of prescribed product safety standards. Moreover, the mark indicates that the manufacturer's production site conforms to a range of compliance measures and is subject to periodic follow-up inspections to verify continued conformance.

Circuit	British Main Wiring Name	American Main Wiring Name	Description	Symbol	IEC 60617
SPST	One Way	Two Way	Single Pole Single Throw A simple on-off switch: The two terminals are either connected together or not connected to anything.		
SPDT	Two Way	Three Way	Single Pole Double Throw A simple changeover switch: C (Common) is connected to L1 or to L2.		
DPST	Double Pole	Double Pole	Double Pole Single Throw Equivalent to two SPST switches controlled by a single mechanism		
DPDT			Double Pole Double Throw A term used to describe a switch or relay output contact Form (Form CC) in which two separate switches are operating simultaneously, each with a normally open and normally closed contact and common connection. This form is used to make and break to separate circuits.		
TPDT			Triple Pole Double Throw		

Switches with larger numbers of poles or throws can be described by replacing the "S" or "D" with a number or in some cases the letter T (for triple).

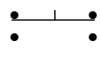
EXAMPLE OF CIRCUIT DESCRIPTIONS

CIRCUIT	TREADLE UP	TREADLE DOWN	CIRCUIT	TREADLE UP	TREADLE DOWN
SPDT			SPDT DB (Double Break)		

Term	Description
DB	Double Break A form of contact construction in which a current carrying member bridges a gap in an otherwise complete circuit, thus breaking the current at two adjacent points, one at each end of the bridging member. This breaks the circuit in two places. Also referred to as Form Z circuitry.
NC	Normally Closed In normally closed (N.C) contact blocks, the contacts are "at rest" in the closed (on) position, allowing current to pass through. The contacts open only when the plunger goes down and separates them.
NO	Normally Open Normally open (N.O) means that contacts are "at rest" in the open (off) position, and current does not pass through. The contacts close only when the plunger goes down and forces them together.
MBB	Make before Break In a multi-throw switch, the new contact is made before the old contact is broken. This is known as make-before-break, and ensures that the moving contact never sees an open circuit.
BBM	Break before Make In a multi-throw switch, the old contact is broken before the new one is made. This is known as break-before-make, and ensures that the two fixed contacts are never shorted to each other.
Hall Effect Sensor	A Hall Effect sensor is a transducer that varies its output voltage in response to changes in magnetic field. Hall sensors are used for proximity switching, positioning, speed detection, and current sensing applications.
Maintained	Press - on, Press again - off. When a maintained action switch is actuated, the contacts move to transfer the circuits to the second set of contacts. No change takes place with the contacts when the operator removes his or her foot even though the actuator, treadle or cover, has returned to the original position. When the operator actuates the switch a second time, the contacts returns to the original position.
Momentary	Press - on, release - off. When a momentary action switch is actuated, the actuating device, treadle or cover, and contacts move to transfer the circuits to a second set of contacts. When the actuating force is removed, the actuating device and the contacts return to the original position.
Reed Switch	The reed switch is an electrical switch operated by an applied magnetic field. It was invented at Bell Telephone Labs in 1936 by W. B. Elwood. It consists of a pair of contacts on ferrous metal reeds in a hermetically sealed glass envelope. The contacts may be normally open, closing when a magnetic field is present, or normally closed and opening when a magnetic field is applied.
Variable	The present popular usage of the term potentiometer (or 'pot' for short) describes an electrical device which has a user-adjustable resistance. Usually, this is a three-terminal resistor with a sliding contact in the center (the wiper). If all three terminals are used, it can act as a variable voltage divider. If only two terminals are used (one side and the wiper), it acts as a variable resistor.



AMERICA'S FOOT SWITCH LEADER

MISSION STATEMENT

Linemaster Switch Corporation's mission is to provide a superior foot switch at an affordable price without compromise.

QUALITY POLICY

We are committed to provide the highest standard quality products and services that will meet or exceed our Customers' requirements, comply with regulatory requirements, and to maintain and improve the effectiveness of the quality management system.

COMMITMENT STATEMENT

Linemaster is committed to continuously improving the effectiveness of the quality management system through the establishment and monitoring of relevant quality goals and metrics throughout the organization. We will strive for the improvement of product quality, the reduction in quality cost, and the increase in productivity and efficiency. Basic principle is that all departments and individuals have responsibilities in ensuring that their job is done correctly and the product is built right the first time and every time thereafter. Our program emphasizes preventive efforts and systems

We endorse the concepts, policies, and elements described in the system, and will monitor the performance throughout the organization and through periodic reviews of the quality management system by Linemaster management.

WARNING

USE OF FOOT CONTROLS ON MACHINERY LACKING EFFECTIVE POINT OF OPERATION SAFEGUARDS CAN CAUSE SERIOUS INJURY TO THE OPERATOR.

Foot controls should only be used where “Point of Operation” and “Pinch Point” guarding devices have been properly installed and are utilized so that it is IMPOSSIBLE for the operator’s hands or fingers to remain within the point of operation during the machine cycle.

POINT OF OPERATION - The point or area of the machine or equipment where the work piece or material is actually positioned and work is being performed during any process such as cutting, shearing, punching, forming, welding, riveting, assembling, etc.

PINCH POINT - Any point at which it is possible for a portion of the body to be caught and injured between moving machine or equipment or work piece parts.

IT IS THE RESPONSIBILITY OF THE USER - to determine the suitability of a foot control for the user’s intended use and to determine that the foot control chosen by the user and wiring up and installation of same will comply with all Federal, State and Local safety and health regulations and codes.

Due to the unlimited variety of business equipment, instruments, machines and vehicles on which our foot switches are used, the thousands of standards, and customers’ varying interpretations of the standards covering these applications, it is impossible for LINEMASTER® personnel to be experts on standards and requirements for all these products. We offer over 550 stock foot switch models and guards plus a large variety of specials which are made to customer specifications. We can advise you what is available in our foot switch line and you can examine models to see what meets your needs. We believe our customers’ engineering departments should be the qualified experts in their own product field and know what specifications or details they may require in a foot switch for their equipment. If one of our stock models meets their needs, they can specify it, or possibly ask for a modification of a stock model if that is required.

SHOULD YOU HAVE ANY QUESTIONS OR IF ANY OF THE ABOVE WARNING IS UNCLEAR, PLEASE CALL LINEMASTER® SWITCH CORPORATION.

LINEMASTER® SWITCH CORPORATION reserves the right to discontinue or change specifications, designs or materials, without notice consistent with sound engineering principles and modern practices.



LINEMASTER SWITCH CORPORATION

29 Plaine Hill Road, POB 238
Woodstock, CT 06281-0238 USA

Business Hours

7:00am to 4:30pm Monday - Friday
(Eastern Standard Time-EST)

Telephone (860) 974-1000

Fax: (860) 974-0691
(800) 974-3668 (Toll Free US Only)

www.linemaster.com