

# GP12

## Efficient, High-Speed Robot

### Key Benefits

Highest payload, speeds and wrist allowable moment in its class

Space-efficient design

Engineered for easy installation, operation and maintenance

### Specifications

12 kg payload  
1,440 mm horizontal reach  
2,511 mm vertical reach  
±0.06 mm repeatability

### Applications

Assembly

Material Handling

Packaging

### Controller

YRC1000

YRC1000micro



- Increase your productivity with the fast and efficient GP12 robot.
- All axis speeds have been increased by up to 15% - surpassing other robots in its class.
- Reduced interference design allows close proximity placement of robots.
- Maximum reduction of acceleration/ deceleration times for all robot positions.
- Hollow arm structure eliminates cable interference.
- Highest wrist allowable moment for accurate and repeatable handling.
- Higher payload allows wider range of tooling integration such as double gripper for multi-handling operations.
- Single power and control cable reduces wiring time and increases work efficiency.
- New robot harness design for improved diagnostics and maintenance.
- Home position data can be saved without battery connection for easy maintenance.
- Ideal for high-volume assembly, handling and packaging applications.
- NSF-H1 certified food-grade lubricant option available for food or consumer product packaging environments.
- The GP12 has an IP67-rated wrist and an IP54 body standard. An XP (eXtra Protection) package that increases the body protection rating to IP65 is available.
- The GP12 can be floor-, wall-, tilt- or ceiling-mounted. Brakes are included on all axes.
- The GP12 robot is available with either the standard teach pendant or the Smart Pendant.

# GP12 Robot

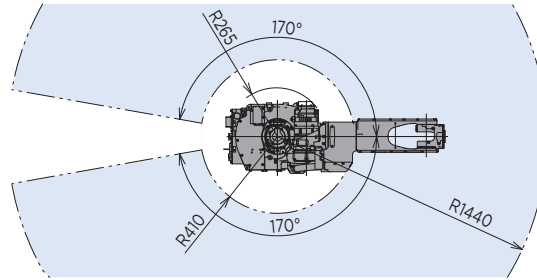
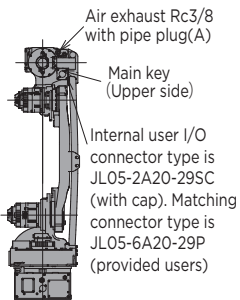
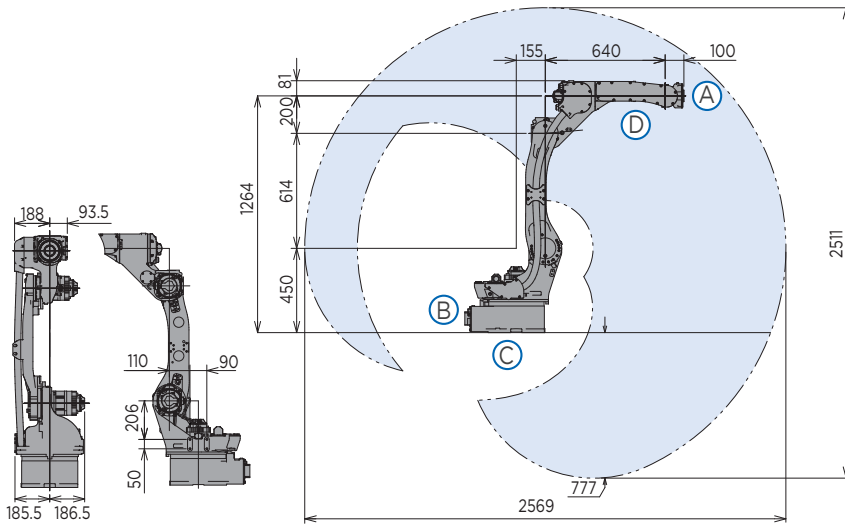

## VIEW A

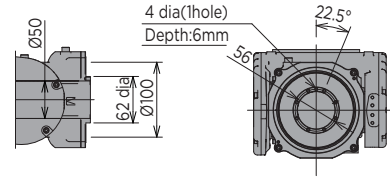

## VIEW B

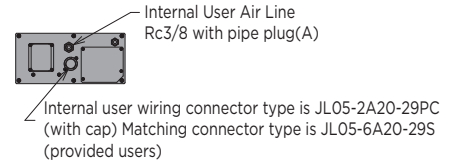

## VIEW C

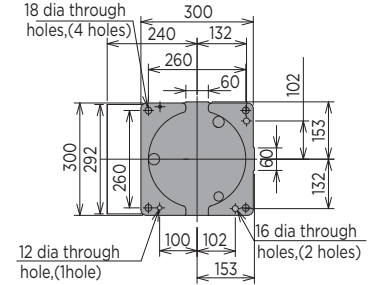

## VIEW D

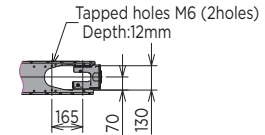

All dimensions are metric (mm) and for reference only. Request detailed drawings for all design/engineering requirements.

## SPECIFICATIONS

Axes	Maximum motion range [°]	Maximum speed [°/sec.]	Allowable moment [N•m]	Allowable moment of inertia [kg•m <sup>2</sup> ]
S	±170	260	-	-
L	+155/-90	230	-	-
U	+150/-85	260	-	-
R	±200	470	22	0.65
B	±150	470	22	0.65
T	±455	700	9.8	0.17

Specifications for GP12 with XP package may be different.

Mounting Options: Floor, Wall, Tilt or Ceiling

\* The MLX300 software option is not available for use with arc or spot welding applications. MLX300 fieldbus cards, I/O cards and vision equipment must be purchased separately from the supplier. All peripherals are programmed using a PLC.

\*\* Food grade grease version includes (2) 3/8" internal user air line connections.

Item	GP12
Controlled axes	6
Maximum payload [kg]	12
Repeatability [mm]	±0.06
Horizontal reach [mm]	1,440
Vertical reach [mm]	2,511
Weight [kg]	150
Internal user I/O cable	17 conductors (+ ground)
Internal user air line	(1) 3/8" connection**
Power requirements	
YRC1000	Three-phase 380-480 VAC 50/60 Hz
YRC1000micro	Three-phase 200-230 VAC 50/60 Hz
Power rating [kVA]	1.5

## Options

- Robot risers and base plates
- MotoSight™ 2D and 3D vision systems
- PLC integration via MLX300 software option\*

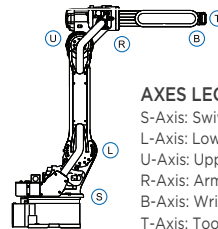

### AXES LEGEND

- S-Axis: Swivel Base
- L-Axis: Lower Arm
- U-Axis: Upper Arm
- R-Axis: Arm Roll
- B-Axis: Wrist Bend
- T-Axis: Tool Flange

**Yaskawa America, Inc. | Motoman Robotics Division**  
 100 Automation Way  
 Miamisburg, OH 45342  
 Tel: 937.847.6200 | motoman.com

# YASKAWA